

Cennik dla klientów prowadzących działalność na rynku profesjonalnym

**CENNIK**

Obowiązuje od 01.05.2012

B2B

[ **biuro** ]

gabinet menedżerski

biuro

sala konferencyjna

poczekalnia

pokój dziecięcy

przyjazne krzesła do każdego wnętrza



# [ SPIS TREŚCI ]

**P** – OFERTA PREMIUM  
**S** – OFERTA STANDARD  
**EX** – OFERTA EXPRESS

kolejność alfabetyczna

28 @-MOTION <b>P</b>	80 CLUB SQ <b>P</b>	4 INTRATA <b>P EX</b>	14 NEO LUX <b>P</b>	26 SIT.ON <b>P</b>
8 AMADEUS <b>S</b>	32 COMFORT <b>P</b>	10 INVITUS <b>P EX</b>	86 NEO LUX 4L <b>P</b>	44 SMART <b>S</b>
8 AMBASADOR <b>S</b>	82 CONECT II <b>P</b>	64 IRYS <b>S</b>	16 NEXT_U <b>P</b>	50 SMART RB <b>S</b>
54 AMIGO <b>P</b>	62 CORTESSA <b>S EX</b>	64 ISO <b>P S EX</b>	18 NOVA <b>P</b>	22 SONATA <b>P</b>
28 AMIGO GTP <b>P</b>	32 DROP <b>S</b>	34 JUMP <b>P</b>	40 OFFICER NET <b>P</b>	24 STAR <b>P</b>
56 ARIOSO <b>S EX</b>	10 ELF <b>S</b>	70 KELLY <b>S</b>	20 ORBIT <b>EX</b>	90 STEP <b>P</b>
97 ARIZONA <b>EX</b>	62 ELVA <b>P</b>	97 LARA INOX <b>P</b>	20 ORION <b>S</b>	44 STILLO <b>P EX</b>
8 ARTUS <b>P</b>	96 ERYK <b>P</b>	72 LATTE <b>P EX</b>	40 ORLANDO <b>P</b>	76 STYL <b>S EX</b>
56 ASCONA <b>S</b>	62 ESPRESSO <b>P</b>	36 LATTE GTS <b>P</b>	74 PATRIZIA <b>S</b>	76 SYLWIA <b>S S</b>
80 ATHENA <b>P</b>	32 ESPRESSO GTP <b>P</b>	12 LINEA <b>EX</b>	40 PERFECT <b>EX</b>	44 TAKTIK <b>S</b>
80 ATRIUM <b>P</b>	30 EXTREME II <b>P</b>	74 LOCO II <b>P</b>	48 PICCOLO <b>S</b>	44 TEMA <b>S</b>
48 BAMBINO <b>S</b>	62 FANO <b>P</b>	74 MALVA <b>P</b>	74 POLYFOLD <b>S</b>	97 TOP <b>P</b>
56 BETA <b>S EX</b>	62 FIUGGI <b>P</b>	12 MANAGER <b>S</b>	20 PREMIER <b>S</b>	76 VESTA <b>S</b>
58 BINGO <b>P</b>	62 FONDO <b>P</b>	100 MEBLE EXPRESS <b>EX</b>	42 PRESTIGE <b>S</b>	76 VISA <b>S</b>
28 BINGO GTP <b>P</b>	10 FORMULA <b>P</b>	12 MEFISTO 2002 <b>EX</b>	42 QUATRO <b>P</b>	76 V-SIT <b>EX</b>
30 BIZZI <b>P</b>	64 FRAPPE <b>EX</b>	12 METEOR <b>P</b>	20 RAPSODY <b>P</b>	88 WAIT <b>P</b>
48 BOBI <b>S</b>	10 GALAXY <b>S</b>	36 MIND <b>P</b>	42 REFLEX <b>EX</b>	46 WEBST@R <b>P EX</b>
30 BOLERO II <b>P</b>	34 GEM <b>P</b>	48 MINISTYLE <b>S</b>	96 RICO <b>S EX</b>	52 WEREK <b>S</b>
60 CAPPUCINO <b>P EX</b>	34 GENER@TION <b>S</b>	14 MIRAGE <b>S</b>	42 ROXY <b>P</b>	24 WIESZAK FOTELOWY <b>P</b>
48 CARTOONS LINE <b>S</b>	50 GOLIAT <b>S</b>	38 MONTANA <b>P</b>	86 SAMBA <b>P EX</b>	78 WING <b>P</b>
8 CHESTER <b>P</b>	34 GRAND <b>S</b>	14 NADIR <b>S</b>	22 SENATOR <b>P</b>	52 WORKER <b>S</b>
30 CINQUE <b>P</b>	82 HELLO! <b>P</b>	50 NEGRO <b>S</b>	50 SENIOR <b>S</b>	46 XL PRO <b>S EX</b>
60 CINQUE 4L <b>P</b>	64 IBIS <b>P</b>	50 NEGRO II <b>S</b>	98 SIMPLE <b>P</b>	24 ZENIT <b>S</b>
80 CLUB <b>S EX</b>	34 INSPIRE <b>P</b>	38 NEO II <b>P</b>	26 SIT.NET <b>P</b>	24 ZORBA <b>S</b>

## KILKA WSKAZÓWEK

- ▶ Wszystkie krzesła, z wyłączeniem krzesła dziecięcych oraz fotela Sonata 24/7, przeznaczone są do użytkowania przez 8 h dziennie przez osoby ważące do 110 kg wg limitów zawartych w normie PN EN 1335.
- ▶ Podane wymiary mogą się różnić od rzeczywistych o  $\pm 2\%$ .
- ▶ Każdy produkt w cenniku posiada termin realizacji zależny od rodzaju oferty i wykończenia.
- ▶ Szczegółowe wykończenia metalowe (chrome, alu, kwarc lub black) umieszczone są obok nazwy produktu.
- ▶ Produkt występuje w wykończeniach tapicerek, przy których znajdują się ceny.
- ▶ Istnieje możliwość zamówienia modeli w niestandardowych wykończeniach lub wersjach niewystępujących w cenniku za **dodatkową dopłatą 25%** do ustalonej ceny netto. Realizacja zamówienia nastąpi po uzgodnieniu z Działem Sprzedaży Krajowej terminu i zaakceptowaniu oferty.
- ▶ Wszystkie produkty posiadają 2 lata gwarancji.
- ▶ Wszystkie fotele i krzesła obrotowe posiadają 4 lata gwarancji na podnośnik pneumatyczny.
- ▶ Firma Nowy Styl zastrzega sobie prawo do:
  - zmian konstrukcyjnych,
  - zmian wymiarów,
  - zmian terminów dostaw,
  - usunięcia produktów,
  - zmian w palecie wykończeń.

## ZNACZENIE IKON



– Produkt posiada Certyfikat Sprawdzonego Bezpieczeństwa GS nadany przez TÜV Rheinland Group.

**REMODEX** – Produkt posiada Atest Badań Wytrzymałościowych wydany przez Zakład Badań i Wdrożeń Przemysłu Meblarskiego P.U.R. – Remodex Sp. z o.o.



– Produkt posiada Certyfikat Wytrzymałościowy włoskiego Instytutu Badań CATAS S.p.A.



– Produkt posiada Protokół Oceny Ergonomicznej wydany przez Instytut Medycyny Pracy im. Prof. J. Nofera.



– Nowy produkt lub nowa wersja.



– **3 lata** na produkt, **5 lat** na podnośnik pneumatyczny.



## INTRATA

strona 2–7

KONFIGURATOR MODELI	2–3	INTRATA M	4	INTRATA V	6–7
		INTRATA O	5, 7		

## FOTELE MENEDŻERSKIE

strona 8–25

AMADEUS	8	INVITUS	10–12	NEO LUX	14–16	SENATOR	22
AMBASADOR	8	LINEA	12	NEXT_U	16–18	SONATA	22–24
ARTUS	8	MANAGER	12	NOVA	18–20	STAR	24
CHESTER	8–10	MEFISTO 2002	12	ORBIT	20	ZENIT	24
ELF	10	METEOR	12–14	ORION	20	ZORBA	24
FORMULA	10	MIRAGE	14	PREMIER	20		
GALAXY	10	NADIR	14	RAPSODY	20–22		

## KRZESŁA OBROTOWE

strona 26–47

@-MOTION	28	EXTREME II	32	NEO II	38	SIT.ON	26
AMIGO GTP	28	GEM	34	OFFICER NET	40	SMART	44
BINGO GTP	28	GENER@TION	34	ORLANDO	40	STILLO	44
BIZZI	30	GRAND	34	PERFECT	40	TAKTIK	44–46
BOLERO II	30	INSPIRE	34	PRESTIGE	42	TEMA	46
CINQUE	30–32	JUMP	34–36	QUATRO	42	WEBST@R	46
COMFORT	32	LATTE GTS	36	REFLEX	42	XL PRO	46
DROP	32	MIND	36	ROXY	42		
ESPRESSO GTP	32	MONTANA	38	SIT.NET	26		

## KRZESŁA DZIECIĘCE

strona 48–49

BAMBINO	48	CARTOONS LINE	48	PICCOLO	48
BOBI	48	MINISTYLE	48		

## KRZESŁA DO ZASTOSOWAŃ SPECJALISTYCZNYCH

strona 50–53

GOLIAT	50	NEGRO II	50	SMART	50–52	WORKER	52
NEGRO	50	SENIOR	50	WEREK	52		

## KRZESŁA I STOŁY DO POCZEKALNI I SAL KONFERENCYJNYCH

strona 54–99

AMIGO	54	CONECT II	82	IRYS	64	SAMBA	86–88
ARIOSO	56	CORTESSA	62	ISO	64–70	SIMPLE	98–99
ASCONA	56	ELVA	62	KELLY	70	STEP	90–94
ATHENA	80	ERYK	96	LARA INOX	97	STYL	76
ATRIUM	80	ESPRESSO	62	LATTE	72–74	SYLWIA S	76
BETA	56	FANO	62	LOCO II	74	VESTA	76
BINGO	58–60	FIUGGI	62	MALVA	74	VISA	76
CAPPUCINO	60	FONDO	62–64	NEO LUX	86	V-SIT	76–78
CINQUE 4L	60	FRAPPE	64	PATRIZIA	74	WAIT	88
CLUB	80	HELLO!	82–86	POLYFOLD	74	WING	78
CLUB SQ	80–82	IBIS	64	RICO	96		

## WIESZAKI

strona 24, 97

ARIZONA	97	TOP	97	WIESZAK FOTELOWY	24
---------	----	-----	----	------------------	----

## MEBLE EXPRESS

strona 100–105

## ZESTAWIENIE TKANIN

strona 106–107

## ZNACZENIE SYMBOLI, KÓŁKA

strona 108

Krzesła INTRATA zostały zaprojektowane z myślą o użytkownikach – żeby stworzyć własne unikalne krzesło dla każdego miejsca pracy wystarczy wybrać preferowane rozwiązanie spośród szerokiej gamy rodzajów i kolorów tapicerek, mechanizmów ruchowych, podstaw, podłokietników i innych, dodatkowych elementów.

Linia INTRATA umożliwia stworzenie ponad 760 konfiguracji foteli i krzesel, co pozwala na spójne wizualnie wyposażenie wnętrza i zachowanie indywidualnego stylu!

## KONFIGURATOR MODELI

### INTRATA

M (MANAGER) lub O (OPERATIVE) lub V (VISITOR) –

OPARCIE	PODSTAWA/ RAMA	PODŁOKIETNIKI	MECHANIZM	KÓŁKA
---------	-------------------	---------------	-----------	-------

### MANAGER

OPARCIE	PODSTAWA	PODŁOKIETNIKI	MECHANIZM	KÓŁKA
21	TS16 BL	GTS	ES	SH
22	ST36 CR	GTP36	ESPT	SHH
22 HRU	ST36 ALU	R20N		ESH
23				ESHH
23 HRU				

### OPERATIVE

OPARCIE	PODSTAWA	PODŁOKIETNIKI	MECHANIZM	KÓŁKA
11	TS16 BL	GTS	AN	SH
12	ST36 CR	GTP36	ES	SHH
12 HR	ST36 ALU	R20N		ESH
12 HRU				ESHH
13				
13 HR				
13 HRU				

### VISITOR

OPARCIE	RAMA	Podłokietniki
31	CF BL	NA
32	CF CR	ARM
	CF ALU	
	FL BL	
	FL CR	
	FL ALU	

## PRZYKŁADY NAZEWNICTWA

INTRATA M – 21 – TS16 BL – GTS – ES – SH

INTRATA M – 22 HRU – ST36 CR – GTP36 – ESPT – SHH

INTRATA O – 11 – TS16 BL – GTS – AN – SH

INTRATA O – 12 HRU – ST36 CR – R20N – ES – ESHH

INTRATA V – 31 – CF BL – NA

INTRATA V – 32 – FL CR – ARM

## OPARCIA

11	oparcie Operative tapicerowane niskie
12	oparcie Operative tapicerowane wysokie
12 HR	oparcie Operative tapicerowane wysokie ze stałym zagłówkiem plastikowym
12 HRU	oparcie Operative tapicerowane wysokie z zagłówkiem tapicerowanym stałym
13	oparcie Operative siatkowe wysokie
13 HR	oparcie Operative siatkowe wysokie z zagłówkiem plastikowym stałym
13 HRU	oparcie Operative siatkowe wysokie z zagłówkiem tapicerowanym stałym
21	oparcie Manager tapicerowane niskie
22	oparcie Manager tapicerowane wysokie
22 HRU	oparcie Manager tapicerowane wysokie z zagłówkiem tapicerowanym regulowanym
23	oparcie Manager siatkowe wysokie
23 HRU	oparcie Manager siatkowe wysokie z zagłówkiem tapicerowanym regulowanym
31	oparcie Visitor tapicerowane
32	oparcie Visitor siatkowe

## PODSTAWY

TS16 BL	5-ramienna podstawa nylonowa czarna
ST36 CR	5-ramienna podstawa aluminiowa w wykończeniu chrome (polerowane aluminium)
ST36 ALU	5-ramienna podstawa aluminiowa w wykończeniu alu (pokryta lakierem w kolorze alu)
CF BL	pfoza: stalowa rama pokryta lakierem w kolorze czarnym
CF CR	pfoza: stalowa rama chromowana
CF ALU	pfoza: stalowa rama pokryta lakierem w kolorze alu
FL BL	4 nogi: stalowa rama pokryta lakierem w kolorze czarnym
FL CR	4 nogi: stalowa rama chromowana
FL ALU	4 nogi: stalowa rama pokryta lakierem w kolorze alu

## RAMY

## PODŁOKIETNIKI

GTS	bez podłokietników
GTP36	z podłokietnikami stałymi
R20N	z podłokietnikami regulowanymi
NA	rama bez podłokietników
ARM	rama z podłokietnikami

## MECHANIZMY

AN*	mechanizm Active IN
ES	mechanizm Epron Synchron
ESPT	mechanizm Epron Synchron Plus z regulacją głębokości siedziska

## KÓŁKA

SH	kółka samohamowne (Ø50) do powierzchni miękkich
SHH	kółka samohamowne (Ø50) do powierzchni twardych
ESH	kółka samohamowne (Ø65) do powierzchni miękkich
ESHH	kółka samohamowne (Ø65) do powierzchni twardych

\* Mechanizm Active IN nie może być użyty w konfiguracji z oparciem siatkowym





OPARCIA

INTRATA MANAGER

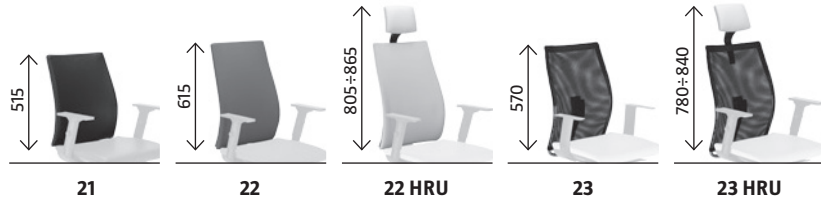

21 22 22 HRU 23 23 HRU

INTRATA OPERATIVE

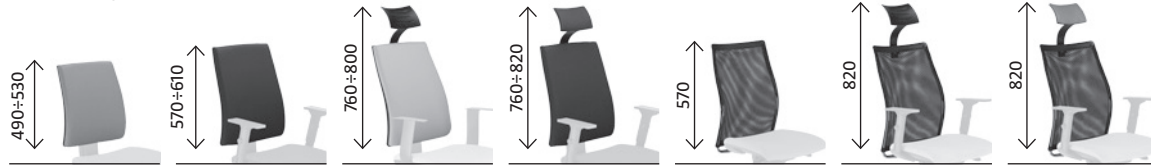

11 12 12 HR 12 HRU 13 13 HR 13 HRU

INTRATA VISITOR

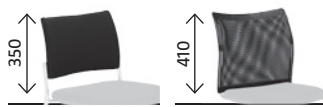

31 32

PODSTAWY



TS16 BL ST36 CR ST36 ALU

MECHANIZMY



AN ES ESPT

RAMY



CF BL CF CR CF ALU FL BL FL CR FL ALU

PODŁOKIETNIKI



GTS GTP36 R2ON NA ARM

KÓŁKA



SH SHH ESH ESHH



REMODEX



termin realizacji 21 dni

## CENA WERSJI PODSTAWOWYCH

OPARCIE	PODSTAWA	PODŁOKIETNIKI	MECHANIZM	KÓŁKA	NAZWA	SKÓRA DWOJNA (SP)	SKÓRA LICOWA (SD/LE)	MICRO (M)	OBAN (EF) LUCIA (YB)	NOBLE LUX (NL) MICROFIBRA (CM)	CONTRACT (YN) NEXUS (UNY)	OXYGEN (OX)
tapicerowane niskie [21]	nylonowa czarna [TS16 BL]	bez podłokietników [GTS]	Epron Synchron [ES]	samohamowne do powierzchni miękkich (Ø50) [SH]	INTRATA M – 21 – TS16 BL – GTS – ES – SH	744 netto <b>915,12 brutto</b>	860 netto <b>1057,8 brutto</b>	622 netto <b>765,06 brutto</b>	639 netto <b>785,97 brutto</b>	672 netto <b>826,56 brutto</b>	689 netto <b>847,47 brutto</b>	719 netto <b>884,37 brutto</b>
tapicerowane wysokie [22]					INTRATA M – 22 – TS16 BL – GTS – ES – SH	772 netto <b>949,56 brutto</b>	901 netto <b>1108,23 brutto</b>	643 netto <b>790,89 brutto</b>	659 netto <b>810,57 brutto</b>	695 netto <b>854,85 brutto</b>	713 netto <b>876,99 brutto</b>	743 netto <b>913,89 brutto</b>
tapicerowane, wysokie z zagłówkiem tapicerowanym, regulowanym [22 HRU]					INTRATA M – 22 HRU – TS16 BL – GTS – ES – SH	844 netto <b>1038,12 brutto</b>	997 netto <b>1226,31 brutto</b>	701 netto <b>862,23 brutto</b>	719 netto <b>884,37 brutto</b>	758 netto <b>932,34 brutto</b>	779 netto <b>958,17 brutto</b>	809 netto <b>995,07 brutto</b>
siatkowe wysokie [23]					INTRATA M – 23 – TS16 BL – GTS – ES – SH	799 netto <b>982,77 brutto</b>	867 netto <b>1066,41 brutto</b>	742 netto <b>912,66 brutto</b>	751 netto <b>923,73 brutto</b>	777 netto <b>955,71 brutto</b>	791 netto <b>972,93 brutto</b>	818 netto <b>1006,14 brutto</b>
siatkowe, wysokie z zagłówkiem tapicerowanym, regulowanym [23 HRU]					INTRATA M – 23 HRU – TS16 BL – GTS – ES – SH	878 netto <b>1079,94 brutto</b>	973 netto <b>1196,79 brutto</b>	806 netto <b>991,38 brutto</b>	817 netto <b>1004,91 brutto</b>	846 netto <b>1040,58 brutto</b>	864 netto <b>1062,72 brutto</b>	897 netto <b>1103,31 brutto</b>

## CENA DODATKÓW (dopłata do wersji podstawowych)

typ podstawy	alumiuniowa w wykończeniu alu (pokryta lakierem w kolorze alu) [ST36 ALU]	111 netto	<b>136,53 brutto</b>
	alumiuniowa w wykończeniu chrome (polerowane aluminium) [ST36 CR]	120 netto	<b>147,6 brutto</b>
podłokietniki	podłokietniki stałe [GTP36]	59 netto	<b>72,57 brutto</b>
	podłokietniki regulowane [R20N]	94 netto	<b>115,62 brutto</b>
mechanizm	Epron Synchron Plus z regulacją głębokości siedziska [ESPT]	214 netto	<b>263,22 brutto</b>
kółka	samohamowne do powierzchni twardych (Ø50) [SHH]	11 netto	<b>13,53 brutto</b>
	samohamowne do powierzchni miękkich (Ø65) [ESH]	21 netto	<b>25,83 brutto</b>
	samohamowne do powierzchni twardych (Ø65) [ESHH]	34 netto	<b>41,82 brutto</b>

## Przykładowe modele z linii:

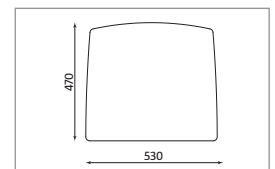
→ INTRATA M –  
22 HRU – ST36 CR –  
R20N – ESPT – SH→ INTRATA M –  
22 – ST36 ALU –  
GTP36 – ES – SH→ INTRATA M –  
23 HRU – ST36 CR –  
R20N – ESPT – SH→ INTRATA M –  
23 – TS16 BL –  
GTP36 – ESPT – SH→ INTRATA M –  
21 – ST36 ALU –  
R20N – ES – SH→ INTRATA M –  
21 – TS16 BL –  
GTP36 – ES – SH

→ Wymiary siedziska

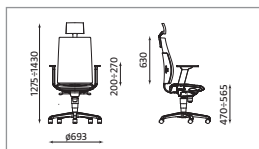
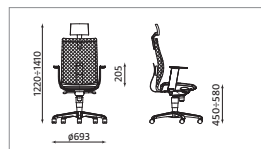
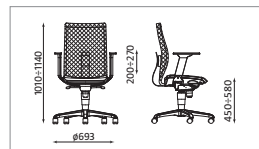
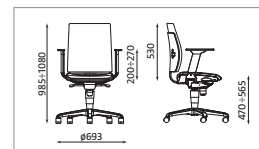
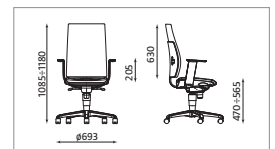
→ INTRATA M –  
22 HRU – ST36 CR –  
R20N – ES – SH→ INTRATA M –  
23 HRU – ST36 CR –  
GTP36 – ES – SH→ INTRATA M –  
23 – ST36 CR –  
R20N – ES – SH→ INTRATA M –  
21 – ST36 CR –  
R20N – ES – SH→ INTRATA M –  
22 – ST36 CR –  
GTP36 – ES – SH

Produkty posiadają Atest Badań Wytrzymałościowych.

Nowy Styl zastrzega sobie prawo do zmian: konstrukcyjnych, wymiarów, terminów dostaw; usunięcia produktów i zmian w palecie wykończeń.



REMODEX



termin realizacji 21 dni

## CENA WERSJI PODSTAWOWYCH

OPARCIE	PODSTAWA	PODŁOKIETNIKI	MECHANIZM	KÓŁKA	NAZWA 	TAPICERKA PODSTAWOWA (C) MICRO (M)	OBAN (EF) LUCIA (YB)	NOBLE LUX (NL) MICROFIBRA (CM)	CONTRACT (YN) NEXUS (UNY)	OXYGEN (OX)
tapicerowane niskie [11]	nylonowa czarna [TS16 BL]	bez podłokietników [GTS]	Active IN [AN] Epron Synchron [ES]	samohamowne do powierzchni miękkich (Ø50) [SH]	INTRATA O – 11 – TS16 BL – GTS – AN – SH	415 netto <b>510,45 brutto</b>	429 netto <b>527,67 brutto</b>	451 netto <b>554,73 brutto</b>	470 netto <b>578,10 brutto</b>	491 netto <b>603,93 brutto</b>
tapicerowane wysokie [12]					INTRATA O – 12 – TS16 BL – GTS – AN – SH	450 netto <b>553,50 brutto</b>	465 netto <b>571,95 brutto</b>	488 netto <b>600,24 brutto</b>	509 netto <b>626,07 brutto</b>	530 netto <b>651,90 brutto</b>
tapicerowane wysokie z zagłówkiem plastikowym stałym [12 HR]					INTRATA O – 12 HR – TS16 BL – GTS – AN – SH	480 netto <b>590,40 brutto</b>	495 netto <b>608,85 brutto</b>	518 netto <b>637,14 brutto</b>	539 netto <b>662,97 brutto</b>	560 netto <b>688,80 brutto</b>
tapicerowane wysokie z zagłówkiem tapicerowanym stałym [12 HRU]					INTRATA O – 12 HRU – TS16 BL – GTS – AN – SH	502 netto <b>617,46 brutto</b>	517 netto <b>635,91 brutto</b>	542 netto <b>666,66 brutto</b>	564 netto <b>693,72 brutto</b>	585 netto <b>719,55 brutto</b>
siatkowe wysokie [13]					INTRATA O – 13 – TS16 BL – GTS – ES – SH	536 netto <b>659,28 brutto</b>	541 netto <b>665,43 brutto</b>	557 netto <b>685,11 brutto</b>	567 netto <b>697,41 brutto</b>	588 netto <b>723,24 brutto</b>
siatkowe wysokie z zagłówkiem plastikowym stałym [13 HR]					INTRATA O – 13 HR – TS16 BL – GTS – ES – SH	566 netto <b>696,18 brutto</b>	572 netto <b>703,56 brutto</b>	587 netto <b>722,01 brutto</b>	598 netto <b>735,54 brutto</b>	619 netto <b>761,37 brutto</b>
siatkowe wysokie z zagłówkiem tapicerowanym stałym [13 HRU]					INTRATA O – 13 HRU – TS16 BL – GTS – ES – SH	588 netto <b>723,24 brutto</b>	594 netto <b>730,62 brutto</b>	612 netto <b>752,76 brutto</b>	623 netto <b>766,29 brutto</b>	644 netto <b>792,12 brutto</b>

## CENA DODATKÓW (dopłata do wersji podstawowych)

typ podstawy	alumiuniowa w wykończeniu alu (pokryta lakierem w kolorze alu) [ST36 ALU]	111 netto	<b>136,53 brutto</b>
	alumiuniowa w wykończeniu chrome (polerowane aluminium) [ST36 CR]	120 netto	<b>147,6 brutto</b>
podłokietniki	podłokietniki stałe [GTP36]	59 netto	<b>72,57 brutto</b>
	podłokietniki regulowane [R20N]	94 netto	<b>115,62 brutto</b>
mechanizm	mechanizm Epron Synchron [ES]	111 netto	<b>136,53 brutto</b>
kółka	samohamowne do powierzchni twardych (Ø50) [SHH]	11 netto	<b>13,53 brutto</b>
	samohamowne do powierzchni miękkich (Ø65) [ESH]	21 netto	<b>25,83 brutto</b>
	samohamowne do powierzchni twardych (Ø65) [ESHH]	34 netto	<b>41,82 brutto</b>

## Przykładowe modele z linii:

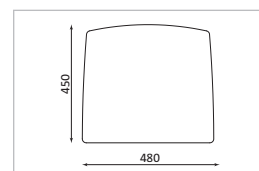
→ INTRATA O –  
12 HRU – ST36 CR –  
R20N – ES – SH→ INTRATA O –  
12 HR – TS16 BL –  
GTP36 – AN – SH→ INTRATA O –  
13 HRU – ST36 CR –  
R20N – ES – SH→ INTRATA O –  
13 – ST36 ALU –  
GTS – ES – SH→ INTRATA O –  
11 – TS16 BL –  
GTP36 – ES – SH→ INTRATA O –  
11 – ST36 ALU –  
GTS – ES – SH

→ Wymiary siedziska

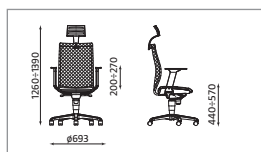
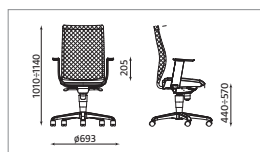
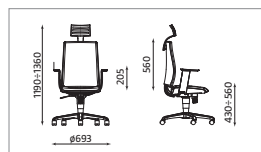
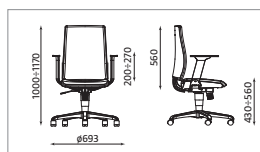
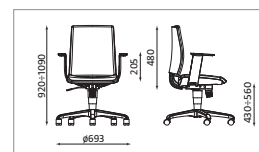
→ INTRATA O –  
13 HR – ST36 CR –  
R20N – ES – SH→ INTRATA O –  
13 – ST36 CR –  
GTP36 – ES – SH→ INTRATA O –  
12 HR – ST36 CR –  
GTP36 – AN – SH→ INTRATA O –  
12 – ST36 CR –  
R20N – AN – SH→ INTRATA O –  
11 – ST36 CR –  
GTP36 – AN – SH



REMODEX



termin realizacji 21 dni

## CENA WERSJI PODSTAWOWYCH

OPARCIЕ	RAMA	PODŁOKIETNIKI	NAZWA 	SKÓRA LICOWA (SD/LE)	TAPICERKA PODSTAWOWA (C) MICRO (M)	OBAN (EF) LUCIA (YB)	MICROFIBRA (CM)	CONTRACT (YN) NEXUS (UNY)	OXYGEN (OX)
tapicerowane [31]	płozą – czarna [CF BL]	rama bez podłokietników [NA]	INTRATA V – 31 – CF BL – NA	442 netto 543,66 brutto	291 netto 357,93 brutto	296 netto 364,08 brutto	308 netto 378,84 brutto	326 netto 400,98 brutto	350 netto 430,50 brutto
	płozą – alu [CF ALU]		INTRATA V – 31 – CF ALU – NA	450 netto 553,50 brutto	299 netto 367,77 brutto	304 netto 373,92 brutto	316 netto 388,68 brutto	334 netto 410,82 brutto	358 netto 440,34 brutto
	płozą – chrome [CF CR]		INTRATA V – 31 – CF CR – NA	488 netto 600,24 brutto	336 netto 413,28 brutto	341 netto 419,43 brutto	352 netto 432,96 brutto	371 netto 456,33 brutto	395 netto 485,85 brutto
siatkowe [32]	płozą – czarna [CF BL]		INTRATA V – 32 – CF BL – NA	447 netto 549,81 brutto	353 netto 434,19 brutto	358 netto 440,34 brutto	366 netto 450,18 brutto	376 netto 462,48 brutto	400 netto 492,00 brutto
	płozą – alu [CF ALU]		INTRATA V – 32 – CF ALU – NA	455 netto 559,65 brutto	362 netto 445,26 brutto	366 netto 450,18 brutto	375 netto 461,25 brutto	384 netto 472,32 brutto	408 netto 501,84 brutto
	płozą – chrome [CF CR]		INTRATA V – 32 – CF CR – NA	503 netto 618,69 brutto	411 netto 505,53 brutto	414 netto 509,22 brutto	423 netto 520,29 brutto	434 netto 533,82 brutto	458 netto 563,34 brutto
tapicerowane [31]	cztery nogi – czarna [FL BL]		INTRATA V – 31 – FL BL – NA	371 netto 456,33 brutto	237 netto 291,51 brutto	241 netto 296,43 brutto	251 netto 308,73 brutto	268 netto 329,64 brutto	290 netto 356,70 brutto
	cztery nogi – alu [FL ALU]		INTRATA V – 31 – FL ALU – NA	378 netto 464,94 brutto	245 netto 301,35 brutto	248 netto 305,04 brutto	259 netto 318,57 brutto	275 netto 338,25 brutto	297 netto 365,31 brutto
	cztery nogi – chrome [FL CR]		INTRATA V – 31 – FL CR – NA	394 netto 484,62 brutto	261 netto 321,03 brutto	264 netto 324,72 brutto	275 netto 338,25 brutto	291 netto 357,93 brutto	313 netto 384,99 brutto
siatkowe [32]	cztery nogi – czarna [FL BL]		INTRATA V – 32 – FL BL – NA	368 netto 452,64 brutto	280 netto 344,40 brutto	286 netto 351,78 brutto	293 netto 360,39 brutto	303 netto 372,69 brutto	327 netto 402,21 brutto
	cztery nogi – alu [FL ALU]		INTRATA V – 32 – FL ALU – NA	376 netto 462,48 brutto	288 netto 354,24 brutto	293 netto 360,39 brutto	300 netto 369,00 brutto	311 netto 382,53 brutto	335 netto 412,05 brutto
	cztery nogi – chrome [FL CR]		INTRATA V – 32 – FL CR – NA	399 netto 490,77 brutto	311 netto 382,53 brutto	316 netto 388,68 brutto	323 netto 397,29 brutto	334 netto 410,82 brutto	358 netto 440,34 brutto

## CENA DODATKÓW (dopłata do wersji podstawowych)

rama z podłokietnikami (ARM), krzesło na płozie (CF)	rama czarna lub alu	34 netto	<b>41,82 brutto</b>
	rama chromowana	42 netto	<b>51,66 brutto</b>
rama z podłokietnikami (ARM), krzesło na nogach (FL)	rama czarna lub alu	16 netto	<b>19,68 brutto</b>
	rama chromowana	25 netto	<b>30,75 brutto</b>

## Przykładowe modele z linii:



→ INTRATA V – 31 – FL BL – ARM

→ INTRATA V – 32 – FL CR – ARM

→ INTRATA V – 32 – CF CR – ARM

→ INTRATA V – 31 – CF CR – ARM

→ INTRATA V – 31 – FL CR – NA

→ INTRATA V – 32 – CF CR – NA

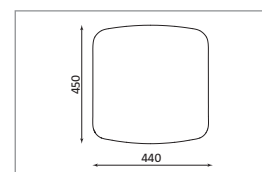

→ Wymiary siedziska

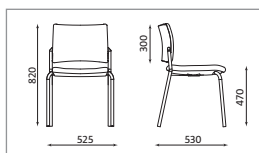

→ INTRATA V – 31 – FL CR – NA

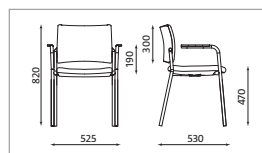

→ INTRATA V – 31 – FL CR – ARM

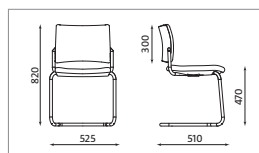

→ INTRATA V – 31 – CF CR – NA

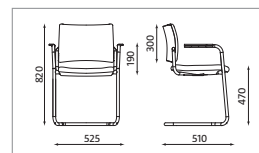

→ INTRATA V – 31 – CF CR – ARM

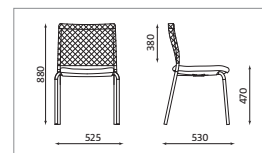

→ INTRATA V – 32 – FL CR – NA

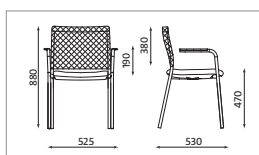

→ INTRATA V – 32 – FL CR – ARM

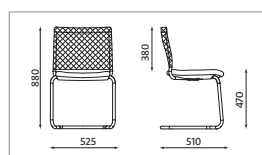

→ INTRATA V – 32 – CF CR – NA

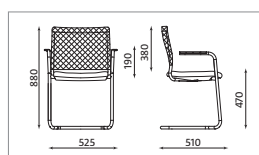

→ INTRATA V – 32 – CF CR – ARM



Produkty posiadają Atest Badań Wytrzymałościowych.











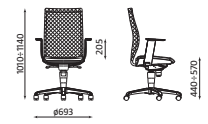

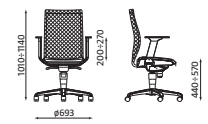
Nowy Styl zastrzega sobie prawo do zmian: konstrukcyjnych, wymiarów, terminów dostaw; usunięcia produktów i zmian w palecie wykończeń.

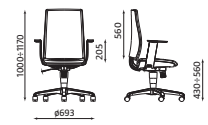



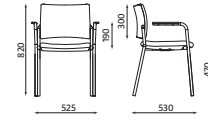

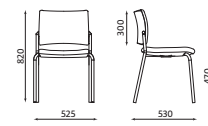





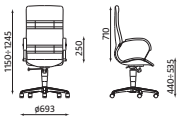

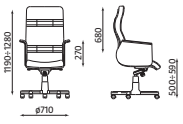

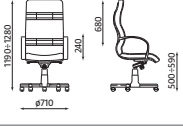







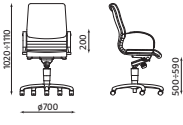



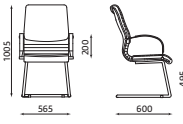



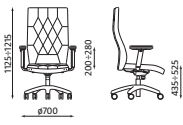

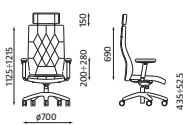

# INTRATA – modele dostępne w ofercie EXPRESS

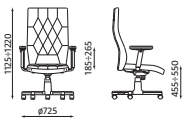

REMODEX

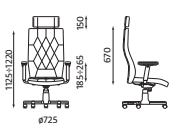

objętość kartonu [m³]	ilość w kartonie [szt.]	waga netto 1 szt. [kg]	siedzisko			<b>MODEL</b> wymiary podane w mm	TERMIN REALIZACJI	WYKOŃCZENIA	CENA [zł]
			szer. [mm]	głęb. [mm]					
0,18	1	13,80	480	450	 	INTRATA O – 13 – TS16 BL – GTP36 – ES – SH	7	EF-809, EF-031 YB-105, YB-026, YB-009, YB-130	600 netto <b>738,00 brutto</b>
0,18	1	13,80	480	450	 	INTRATA O – 13 – TS16 BL – R20N – ES – SH	7	EF-809, EF-031 YB-105, YB-026, YB-009	635 netto <b>781,05 brutto</b>
							5	YB-130	
0,18	1	14,20	480	450	 	INTRATA O – 12 – TS16 BL – GTP36 – AN – SH	7	EF-809, EF-031 YB-105, YB-026, YB-130	524 netto <b>644,52 brutto</b>
							5	YB-009	
0,18	1	14,20	480	450	 	INTRATA O – 12 – TS16 BL – R20N – AN – SH	7	EF-809, EF-031 YB-105, YB-026, YB-130, YB-009	559 netto <b>687,57 brutto</b>
0,36	2	7,80	440	450	 	INTRATA V – 31 – FL CR – ARM	7	EF-809, EF-031 YB-105, YB-026, YB-130	289 netto <b>355,47 brutto</b>
							5	YB-009	
						INTRATA V – 31 – FL KC – ARM	7	EF-809, EF-031 YB-105, YB-026, YB-130, YB-009	264 netto <b>324,72 brutto</b>
0,32	2	7,80	440	450	 	INTRATA V – 31 – FL CR – NA	7	EF-809, EF-031 YB-105, YB-026, YB-130	264 netto <b>324,72 brutto</b>
							5	YB-009	
						INTRATA V – 31 – FL KC – NA	7	EF-809, EF-031 YB-105, YB-026, YB-130, YB-009	248 netto <b>305,04 brutto</b>

ważne informacje	objętość kartonu [m <sup>3</sup> ]	ilość w kartonie [szt.]	waga netto 1 szt. [kg]	siedzisko		MODEL wymiary podane w mm	
				szer. [mm]	głęb. [mm]		
 <b>REMODEX</b>	0,32	1	19,40	550	470	 	AMADEUS steel28 chrome z mechanizmem Tilt
<b>REMODEX</b>	0,36	1	26,10	540	490	 	AMBASADOR z mechanizmem Multiblock
<b>REMODEX</b>	0,36	1	23,60	540	490	 	AMBASADOR extra z mechanizmem Multiblock
  <b>REMODEX</b>	0,33	1	24,00	520	445	 	ARTUS steel04 chrome z mechanizmem Multiblock
  <b>REMODEX</b>	0,33	1	19,90	520	460	 	ARTUS steel04 lb chrome z mechanizmem Multiblock
  <b>REMODEX</b>	0,33	1	17,80	520	460	 	ARTUS steel cf lb chrome
  <b>REMODEX</b>	0,20	1	21,50	525	470	 	CHESTER R23P2 steel28 chrome z mechanizmem Epron Synchron
  <b>REMODEX</b>	0,29	1	22,00	525	470	 	CHESTER HR R23P2 steel28 chrome z mechanizmem Epron Synchron
  <b>REMODEX</b>	0,20	1	21,50	525	470	 	CHESTER EXTRA R23P3 z mechanizmem Epron Synchron
  <b>REMODEX</b>	0,29	1	22,00	525	470	 	CHESTER EXTRA HR R23P3 z mechanizmem Epron Synchron

**DŁUŻSZA  
GWARANCJA**

- 3 lata na produkt
- 5 lat na podnośnik pneumatyczny



Produkty posiadają Atest Badań Wytrzymałościowych.  
Nowy Styl zastrzega sobie prawo do zmian: konstrukcyjnych, wymiarów, terminów dostaw; usunięcia produktów i zmian w palecie wykończeń.

SZCZEGÓŁOWE WYKOŃCZENIE	TERMIN REALIZACJI	CENA MODELU W ZALEŻNOŚCI OD WYKOŃCZENIA [zł]							OFERTA		
		SKÓRA DWOINA (SP)		SKÓRA LICOWA (SD/LE)		MICRO (M) SKAJ (V)	OBAN (EF) LUCIA (YB)	NOBLE LUX (NL) MICROFIBRA (CM) SOTI (SI)		CONTRACT (YN) NEXUS (UNY)	OXYGEN (OX)
		front tapicerowany skórą	front tapicerowany skórą	całość tapicerowana skórą							
	14	994 netto <b>1222,62 brutto</b>	1086 netto <b>1335,78 brutto</b>							S	
1.007, 1.008	21		1163 netto <b>1430,49 brutto</b>							S	
1.007, 1.008	21		1163 netto <b>1430,49 brutto</b>							S	
	14	1095 netto <b>1346,85 brutto</b>	1269 netto <b>1560,87 brutto</b>	1655 netto <b>2035,65 brutto</b>				tylko w YN 1140 netto <b>1402,20 brutto</b>		P	
	14	1077 netto <b>1324,71 brutto</b>	1166 netto <b>1434,18 brutto</b>	1424 netto <b>1751,52 brutto</b>				tylko w YN 1065 netto <b>1309,95 brutto</b>		P	
	14	786 netto <b>966,78 brutto</b>	875 netto <b>1076,25 brutto</b>	1132 netto <b>1392,36 brutto</b>				tylko w YN 774 netto <b>952,02 brutto</b>		P	
	14	1247 netto <b>1533,81 brutto</b>	1369 netto <b>1683,87 brutto</b>	1559 netto <b>1917,57 brutto</b>			tylko w CM 1176 netto <b>1446,48 brutto</b>			P	
	14	1346 netto <b>1655,58 brutto</b>	1466 netto <b>1803,18 brutto</b>	1656 netto <b>2036,88 brutto</b>			tylko w CM 1274 netto <b>1567,02 brutto</b>			P	
DREWNO	14	1247 netto <b>1533,81 brutto</b>	1369 netto <b>1683,87 brutto</b>	1559 netto <b>1917,57 brutto</b>			tylko w CM 1176 netto <b>1446,48 brutto</b>			P	
DREWNO	14	1346 netto <b>1655,58 brutto</b>	1466 netto <b>1803,18 brutto</b>	1656 netto <b>2036,88 brutto</b>			tylko w CM 1274 netto <b>1567,02 brutto</b>			P	













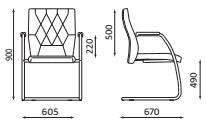

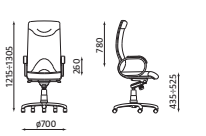

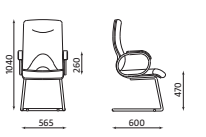

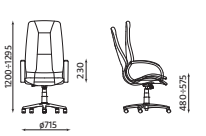

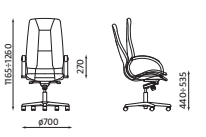

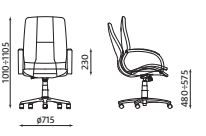

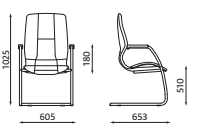
drewno: 1.007, 1.040, 1.010, 1.008, 1.016, 1.042, 1.023, 1.031, 1.033, 1.043

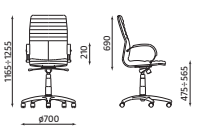
oferta: P – premium, S – standard, EX – express

TERMIN REALIZACJI podano w dniach kalendarzowych.  
ZP – ZA POTWIERDZENIEM – oznacza każdorazowe uzgadnianie terminu realizacji z Działem Handlowym.



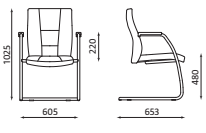

ważne informacje	objętość kartonu [m <sup>3</sup> ]	ilość w kartonie [szt.]	waga netto 1 szt. [kg]	siedzisko		MODEL wymiary podane w mm	 <b>2</b> lata na produkt <b>GWARANCJA</b> <b>lata</b> na podzespoły pneumatyczne <b>4</b>
				szer. [mm]	głęb. [mm]		
 <b>REMDEX</b>	0,45	1	14,90	525	470	 	CHESTER cf/lb chrome
<b>REMDEX</b>	0,32	1	23,80	520	470	 	ELF steel chrome z mechanizmem Multiblock
<b>REMDEX</b>	0,32	1	20,80	520	470	 	ELF steel cf lb chrome
<b>REMDEX</b> 	0,32	1	20,00	550	500	 	FORMULA ts06 z mechanizmem Multiblock
<b>REMDEX</b> 	0,32	1	20,00	550	500	 	FORMULA steel04 chrome z mechanizmem Multiblock
<b>REMDEX</b> 	0,29	1	19,00	550	500	 	FORMULA lb ts06 z mechanizmem Multiblock
<b>REMDEX</b> 	0,51	1	17,00	550	515	 	FORMULA cf lb chrome
<b>REMDEX</b>	0,34	1	19,90	530	475	 	GALAXY steel chrome z mechanizmem Multiblock
<b>REMDEX</b> 	0,18	1	16,00	495	465	 	INVITUS R17M steel36 chrome z mechanizmem Epron Synchron
<b>REMDEX</b> 	0,45	1	14,90	495	465	 	INVITUS cf lb chrome



Produkty posiadają Atest Badań Wytrzymałościowych.

Nowy Styl zastrzega sobie prawo do zmian: konstrukcyjnych, wymiarów, terminów dostaw; usunięcia produktów i zmian w palecie wykończeń.











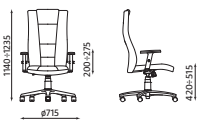

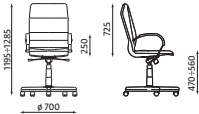

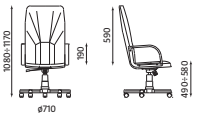

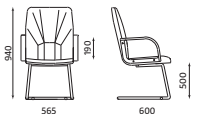

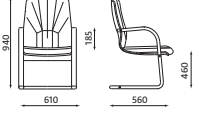

SZCZEGÓŁOWE WYKOŃCZENIE	TERMIN REALIZACJI	CENA MODELU W ZALEŻNOŚCI OD WYKOŃCZENIA [zł]								OFERTA		
		SKÓRA DWOINA (SP)		SKÓRA LICOWA (SD/LE)			MICRO (M) SKAJ (V)	OBAN (EF) LUCIA (YB)	NOBLE LUX (NL) MICROFIBRA (CM) SOTI (SI)		CONTRACT (YN) NEXUS (UNY)	OXYGEN (OX)
		front tapicerowany skórą	front tapicerowany skórą	całość tapicerowana skórą								
DREWNO	14	855 netto <b>1051,65 brutto</b>	976 netto <b>1200,48 brutto</b>	1149 netto <b>1413,27 brutto</b>				tylkow CM 767 netto <b>943,41 brutto</b>			P	
	14		1169 netto <b>1437,87 brutto</b>								S	
	14		794 netto <b>976,62 brutto</b>								S	
	14	950 netto <b>1168,50 brutto</b>	1057 netto <b>1300,11 brutto</b>		tylko w M 792 netto <b>974,16 brutto</b>						P	
	14	1310 netto <b>1611,30 brutto</b>	1418 netto <b>1744,14 brutto</b>	1648 netto <b>2027,04 brutto</b>	tylko w M 1152 netto <b>1416,96 brutto</b>						P	
	14	903 netto <b>1110,69 brutto</b>	1002 netto <b>1232,46 brutto</b>		tylko w M 766 netto <b>942,18 brutto</b>						P	
EMALIA	ZP	837 netto <b>1029,51 brutto</b>	936 netto <b>1151,28 brutto</b>	1139 netto <b>1400,97 brutto</b>	tylko w M 700 netto <b>861,00 brutto</b>						P	
	14	1119 netto <b>1376,37 brutto</b>	1271 netto <b>1563,33 brutto</b>								S	
	14	1087 netto <b>1337,01 brutto</b>	1172 netto <b>1441,56 brutto</b>	1369 netto <b>1683,87 brutto</b>	tylko w M 939 netto <b>1154,97 brutto</b>						P	
EMALIA	ZP	775 netto <b>953,25 brutto</b>	846 netto <b>1040,58 brutto</b>	1015 netto <b>1248,45 brutto</b>	tylko w M 653 netto <b>803,19 brutto</b>						P	

drewno: 1.007, 1.040, 1.010, 1.008, 1.016, 1.042, 1.023, 1.031, 1.033, 1.043  
emalia: 3.097

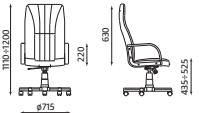
oferta: P – premium, S – standard, EX – express

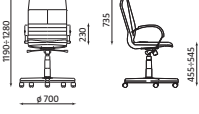
TERMIN REALIZACJI podano w dniach kalendarzowych.  
ZP – ZA POTWIERDZENIEM – oznacza każdorazowe uzgadnianie terminu realizacji z Działem Handlowym.

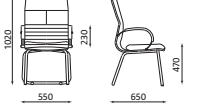

ważne informacje	objętość kartonu [m <sup>3</sup> ]	ilość w kartonie [szt.]	waga netto 1 szt. [kg]	siedzisko		MODEL wymiary podane w mm	 <b>2</b> lata na produkt <b>GWARANCJA</b> <b>lata</b> na podzespoły <b>4</b> <small>przebiegłości</small>
				szer. [mm]	głęb. [mm]		
<b>REMODEX</b>	0,18	1	16,00	495	455	 	<b>INVITUS II</b> z mechanizmem Tilt
<b>REMODEX</b>	0,36	1	22,00	520	440	 	<b>LINEA steel chrome</b> z mechanizmem Multiblock
 <b>REMODEX</b>	0,30	1	18,70	505	480	 	<b>MANAGER</b> z mechanizmem Tilt
 <b>REMODEX</b>	0,27	1	14,55	505	480	 	<b>MANAGER cf/lb</b>
 <b>REMODEX</b>	0,30	1	20,30	505	480	 	<b>MANAGER extra</b> z mechanizmem Tilt
 <b>REMODEX</b>	0,27	1	14,40	505	480	 	<b>MANAGER extra cfn/lb</b>
<b>REMODEX</b>	0,19	1	19,2	525	470	 	<b>MEFISTO 2002</b>
 <b>REMODEX</b>	0,36	1	21,50	530	475	 	<b>METEOR steel chrome</b> z mechanizmem Multiblock
<b>REMODEX</b>	0,34	1	16,00	530	475	 	<b>METEOR steel cfa lb chrome</b>















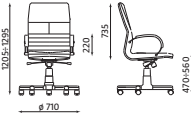

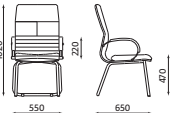



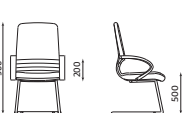

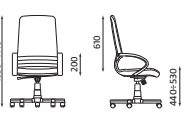

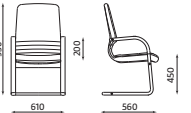
SZCZEGÓŁOWE WYKOŃCZENIE	TERMIN REALIZACJI	CENA MODELU W ZALEŻNOŚCI OD WYKOŃCZENIA [zł]								OFERTA	
		SKÓRA DWOINA (SP)		SKÓRA LICOWA (SD/LE)		MICRO (M) SKAJ (V)	OBAN (EF) LUCIA (YB)	NOBLE LUX (NL) MICROFIBRA (CM) SOTI (SI)	CONTRACT (YN) NEXUS (UNY)		OXYGEN (OX)
		front tapicerowany skórą	front tapicerowany skórą	całość tapicerowana skórą							
	7	tylko w SP-01 768 netto <b>944,64 brutto</b>								EX	
	5	tylko w SP-12 768 netto <b>944,64 brutto</b>									
	7	tylko w SD-16 front, SD-09 front 1129 netto <b>1388,67 brutto</b>								EX	
	5	tylko w SD-01 front 1129 netto <b>1388,67 brutto</b>									
	7	tylko w SD-16 front, SD-09 front, SD-01 front 1123 netto <b>1381,29 brutto</b>								EX	
	14	541 netto <b>665,43 brutto</b>			457 netto <b>562,11 brutto</b>					S	
	ZP	449 netto <b>552,27 brutto</b>			373 netto <b>458,79 brutto</b>					S	
1.007, 1.008, 1.010, 1.031	14	706 netto <b>868,38 brutto</b>			624 netto <b>767,52 brutto</b>					S	
1.007, 1.008, 1.010, 1.031	14	501 netto <b>616,23 brutto</b>			438 netto <b>538,74 brutto</b>					S	
	7	tylko w M-07, M-62 390 netto <b>479,70 brutto</b>								EX	
	5	tylko w M-43 390 netto <b>479,70 brutto</b>									
	14	1070 netto <b>1316,10 brutto</b>	1228 netto <b>1510,44 brutto</b>	1426 netto <b>1753,98 brutto</b>			tylko w NL, CM 1002 netto <b>1232,46 brutto</b>	tylko w YN 1065 netto <b>1309,95 brutto</b>		P	
	14	821 netto <b>1009,83 brutto</b>	977 netto <b>1201,71 brutto</b>	1204 netto <b>1480,92 brutto</b>			tylko w NL, CM 760 netto <b>934,80 brutto</b>	tylko w YN 814 netto <b>1001,22 brutto</b>		P	

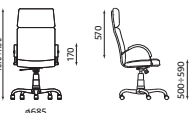
oferta: P – premium, S – standard, EX – express

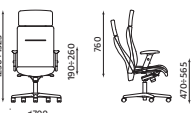
TERMIN REALIZACJI podano w dniach kalendarzowych.

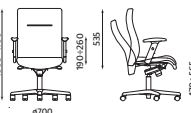
ZP – ZA POTWIERDZENIEM – oznacza każdorazowe uzgadnianie terminu realizacji z Działem Handlowym.

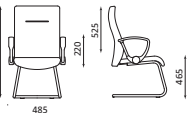

ważne informacje	objętość kartonu [m <sup>3</sup> ]	ilość w kartonie [szt.]	waga netto 1 szt. [kg]	siedzisko		MODEL wymiary podane w mm	 <b>GWARANCJA</b> lata <b>4</b> <small>na podzespoły pneumatyczne</small>
				szer. [mm]	głęb. [mm]		
 <b>REMODEX</b>	0,36	1	26,20	530	475	 	METEOR wood chrome z mechanizmem Multiblock
<b>REMODEX</b>	0,34	1	16,00	530	475	 	METEOR wood cfa lb chrome
<b>REMODEX</b>	0,30	1	16,25	500	510	 	MIRAGE z mechanizmem Tilt
	0,27	1	13,20	500	510	 	MIRAGE cf/lb
	0,30	1	19,15	500	510	 	MIRAGE extra z mechanizmem Tilt
	0,30	1	15,08	500	510	 	MIRAGE extra cfn/lb
 <b>REMODEX</b>	0,30	1	20,10	505	470	 	NADIR steel02 z mechanizmem Tilt
<b>REMODEX</b> 	0,21	1	19,00	490	450	 	NEO LUX PL R1B steel04 chrome z mechanizmem Duetto Synchron /MPD-165/
<b>REMODEX</b> 	0,18	1	16,40	490	450	 	NEO LUX PL lb R1B steel04 chrome z mechanizmem Duetto Synchron /MPD-165/
<b>REMODEX</b> 	0,18	1	12,00	490	460	 	NEO LUX cfp/lb chrome



Produkty posiadają Atest Badań Wytrzymałościowych.

Nowy Styl zastrzega sobie prawo do zmian: konstrukcyjnych, wymiarów, terminów dostaw; usunięcia produktów i zmian w palecie wykończeń.

SZCZEGÓŁOWE WYKOŃCZENIE	TERMIN REALIZACJI	CENA MODELU W ZALEŻNOŚCI OD WYKOŃCZENIA [zł]							OFERTA		
		SKÓRA DWOJNA (SP)		SKÓRA LICOWA (SD/LE)		MICRO (M) SKAJ (V)	OBAN (EF) LUCIA (YB)	NOBLE LUX (NL) MICROFIBRA (CM) SOTI (SI)		CONTRACT (YN) NEXUS (UNY)	OXYGEN (OX)
		front tapicerowany skórą	front tapicerowany skórą	całość tapicerowana skórą							
DREWNO	14	1070 netto <b>1316,10 brutto</b>	1228 netto <b>1510,44 brutto</b>	1426 netto <b>1753,98 brutto</b>			tylko w NL, CM 1002 netto <b>1232,46 brutto</b>	tylko w YN 1065 netto <b>1309,95 brutto</b>		P	
EMALIA	ZP										
DREWNO	14	821 netto <b>1009,83 brutto</b>	977 netto <b>1201,71 brutto</b>	1189 netto <b>1462,47 brutto</b>			tylko w NL, CM 760 netto <b>934,80 brutto</b>	tylko w YN 814 netto <b>1001,22 brutto</b>		P	
EMALIA	ZP										
	21	533 netto <b>655,59 brutto</b>	622 netto <b>765,06 brutto</b>							S	
	ZP	443 netto <b>544,89 brutto</b>	527 netto <b>648,21 brutto</b>							S	
1.007, 1.008, 1.010, 1.031	21	623 netto <b>766,29 brutto</b>	712 netto <b>875,76 brutto</b>							S	
1.007, 1.008, 1.010, 1.031	21	597 netto <b>734,31 brutto</b>	681 netto <b>837,63 brutto</b>							S	
	14	712 netto <b>875,76 brutto</b>	787 netto <b>968,01 brutto</b>							S	
	14	1158 netto <b>1424,34 brutto</b>	1275 netto <b>1568,25 brutto</b>	1445 netto <b>1777,35 brutto</b>						P	
	14	1080 netto <b>1328,40 brutto</b>	1174 netto <b>1444,02 brutto</b>	1307 netto <b>1607,61 brutto</b>						P	
	14	581 netto <b>714,63 brutto</b>	675 netto <b>830,25 brutto</b>	808 netto <b>993,84 brutto</b>						P	

















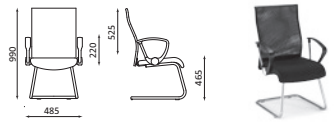



drewno: 1.007, 1.040, 1.010, 1.008, 1.016, 1.042, 1.023, 1.031, 1.033, 1.043  
emalia: 3.097

oferta: P – premium, S – standard, EX – express

TERMIN REALIZACJI podano w dniach kalendarzowych.

ZP – ZA POTWIERDZENIEM – oznacza każdorazowe uzgadnianie terminu realizacji z Działem Handlowym.















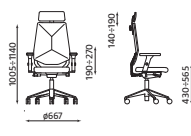

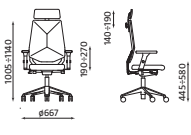



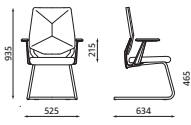



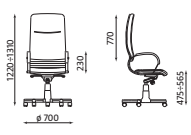

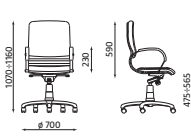

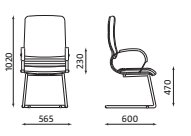

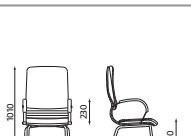
ważne informacje	objętość kartonu [m <sup>3</sup> ]	ilość w kartonie [szt.]	waga netto 1 szt. [kg]	siedzisko		MODEL wymiary podane w mm	 <b>2</b> lata na produkt <b>GWARANCJA</b> <b>lata</b> na podzespoły <b>4</b> pneumatycy
				szer. [mm]	głęb. [mm]		
<b>REMODEX</b> 	0,18	1	14,40	490	450		NEO LUX Ib gts Ring Base steel04 chrome
<b>REMODEX</b> 	0,18	1	17,10	490	460		NEO LUX PL NET R1B steel04 chrome z mechanizmem Duetto Synchron /MPD-165/
	0,18	1	12,00	490	460		NEO LUX NET cfp chrome
<b>REMODEX</b>							NEO LUX 4L ARM
 <b>REMODEX</b> 	0,25	1	18,50	490	405		NEXT_U gtp38 steel29 chrome z mechanizmem Epron Synchron Plus
	0,25	1	20,50	490	405÷465		NEXT_U gtp38 steel29 chrome z mechanizmem Epron Synchron Plus i regulacją głębokości siedziska
	0,25	1	18,00	490	405		NEXT_U R23P1 steel29 chrome z mechanizmem Epron Synchron Plus
	0,25	1	20,00	490	405÷465		NEXT_U R23P1 steel29 chrome z mechanizmem Epron Synchron Plus i regulacją głębokości siedziska
 <b>REMODEX</b>	0,25	1	19,00	490	405		NEXT_U HR gtp38 steel29 chrome z mechanizmem Epron Synchron Plus
	0,25	1	21,00	490	405÷465		NEXT_U HR gtp38 steel29 chrome z mechanizmem Epron Synchron Plus i regulacją głębokości siedziska

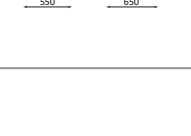

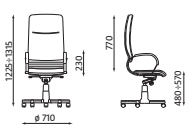

SZCZEGÓŁOWE WYKOŃCZENIE	TERMIN REALIZACJI	CENA MODELU W ZALEŻNOŚCI OD WYKOŃCZENIA [zł]								OFERTA
		SKÓRA DWOINA (SP)	SKÓRA LICOWA (SD/LE)		MICRO (M) SKAJ (V)	OBAN (EF) LUCIA (YB)	NOBLE LUX (NL) MICROFIBRA (CM) SOTI (SI)	CONTRACT (YN) NEXUS (UNY)	OXYGEN (OX)	
		front tapicerowany skórą	front tapicerowany skórą	całość tapicerowana skórą						
	14	663 netto <b>815,49 brutto</b>	757 netto <b>931,11 brutto</b>	890 netto <b>1094,70 brutto</b>			tylko w NL, CM 621 netto <b>763,83 brutto</b>	658 netto <b>809,34 brutto</b>	688 netto <b>846,24 brutto</b>	P
	14	990 netto <b>1217,70 brutto</b>	1036 netto <b>1274,28 brutto</b>				tylko w NL, CM 946 netto <b>1163,58 brutto</b>	964 netto <b>1185,72 brutto</b>	984 netto <b>1210,32 brutto</b>	P
	14	552 netto <b>678,96 brutto</b>	600 netto <b>738,00 brutto</b>				tylko w NL, CM 506 netto <b>622,38 brutto</b>	524 netto <b>644,52 brutto</b>	545 netto <b>670,35 brutto</b>	P
CENY DOTYCZĄCE KRZESŁA NEO LUX 4L ARM NA STRONIE 86										
	14	1353 netto <b>1664,19 brutto</b>	1425 netto <b>1752,75 brutto</b>	1556 netto <b>1913,88 brutto</b>					1386 netto <b>1704,78 brutto</b>	P
	14	1435 netto <b>1765,05 brutto</b>	1507 netto <b>1853,61 brutto</b>	1637 netto <b>2013,51 brutto</b>					1467 netto <b>1804,41 brutto</b>	P
	14	1201 netto <b>1477,23 brutto</b>	1259 netto <b>1548,57 brutto</b>	1390 netto <b>1709,70 brutto</b>					1233 netto <b>1516,59 brutto</b>	P
	14	1281 netto <b>1575,63 brutto</b>	1340 netto <b>1648,20 brutto</b>	1470 netto <b>1808,10 brutto</b>					1315 netto <b>1617,45 brutto</b>	P
	14	1455 netto <b>1789,65 brutto</b>	1536 netto <b>1889,28 brutto</b>	1678 netto <b>2063,94 brutto</b>					1487 netto <b>1829,01 brutto</b>	P
	14	1536 netto <b>1889,28 brutto</b>	1617 netto <b>1988,91 brutto</b>	1760 netto <b>2164,80 brutto</b>					1569 netto <b>1929,87 brutto</b>	P

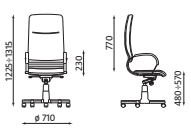
oferta: P – premium, S – standard, EX – express

ważne informacje	objętość kartonu [m <sup>3</sup> ]	ilość w kartonie [szt.]	waga netto 1 szt. [kg]	siedzisko		MODEL wymiary podane w mm	 <b>2</b> lata na produkt <b>GWARANCJA</b> <b>lata</b> na podzespoły <b>4</b> przeznaczony
				szer. [mm]	głęb. [mm]		
	0,25	1	19,00	490	405	 	NEXT_U HR R23P1 steel29 chrome z mechanizmem Epron Synchron Plus
	0,25	1	21,00	490	405÷465	 	NEXT_U HR R23P1 steel29 chrome z mechanizmem Epron Synchron Plus i regulacją głębokości siedziska
 	0,38	1	13,50	490	460	 	NEXT_U cfp lb chrome
 	0,36	1	22,30	520	470	 	NOVA steel alu z mechanizmem Multiblock
	0,34	1	20,90	520	470	 	NOVA steel lb alu z mechanizmem Multiblock
	0,33	1	15,50	520	470	 	NOVA steel lb chrome z mechanizmem Multiblock
	0,34	1	16,40	520	470	 	NOVA steel cfa lb alu
	0,36	1	23,10	520	470	 	NOVA steel cfa lb chrome
 	0,36	1	23,10	520	470	 	NOVA wood alu z mechanizmem Multiblock
	0,36	1	23,10	520	470	 	NOVA wood chrome z mechanizmem Multiblock



SZCZEGÓŁOWE WYKOŃCZENIE	TERMIN REALIZACJI	CENA MODELU W ZALEŻNOŚCI OD WYKOŃCZENIA [zł]								OFERTA	
		SKÓRA DWOJNA (SP)		SKÓRA LICOWA (SD/LE)		MICRO (M) SKAJ (V)	OBAN (EF) LUCIA (YB)	NOBLE LUX (NL) MICROFIBRA (CM) SOTI (SI)	CONTRACT (YN) NEXUS (UNY)		OXYGEN (OX)
		front tapicerowany skórą	front tapicerowany skórą	całość tapicerowana skórą							
	14	1305 netto 1605,15 brutto	1373 netto 1688,79 brutto	1516 netto 1864,68 brutto					1337 netto 1644,51 brutto	P	
	14	1385 netto 1703,55 brutto	1455 netto 1789,65 brutto	1598 netto 1965,54 brutto					1420 netto 1746,60 brutto	P	
	14	1008 netto 1239,84 brutto	1083 netto 1332,09 brutto	1213 netto 1491,99 brutto					1042 netto 1281,66 brutto	P	
	14	1078 netto 1325,94 brutto	1243 netto 1528,89 brutto	1516 netto 1864,68 brutto	tylko w M 878 netto 1079,94 brutto		1016 netto 1249,68 brutto	tylko w YN 1081 netto 1329,63 brutto		P	
	14	1097 netto 1349,31 brutto	1262 netto 1552,26 brutto	1535 netto 1888,05 brutto	tylko w M 897 netto 1103,31 brutto		1035 netto 1273,05 brutto	tylko w YN 1100 netto 1353,00 brutto		P	
	14	1077 netto 1324,71 brutto	1222 netto 1503,06 brutto	1473 netto 1811,79 brutto	tylko w M 860 netto 1057,80 brutto		1014 netto 1247,22 brutto	tylko w YN 1074 netto 1321,02 brutto		P	
	14	1096 netto 1348,08 brutto	1241 netto 1526,43 brutto	1492 netto 1835,16 brutto	tylko w M 879 netto 1081,17 brutto		1033 netto 1270,59 brutto	tylko w YN 1080 netto 1328,40 brutto		P	
	14	879 netto 1081,17 brutto	1024 netto 1259,52 brutto	1275 netto 1568,25 brutto	tylko w M 546 netto 671,58 brutto		816 netto 1003,68 brutto	tylko w YN 876 netto 1077,48 brutto		P	
	14	902 netto 1109,46 brutto	1047 netto 1287,81 brutto	1298 netto 1596,54 brutto	tylko w M 569 netto 699,87 brutto		839 netto 1031,97 brutto	tylko w YN 899 netto 1105,77 brutto		P	
	14	879 netto 1081,17 brutto	1024 netto 1259,52 brutto	1275 netto 1568,25 brutto	tylko w M 546 netto 671,58 brutto		816 netto 1003,68 brutto	tylko w YN 876 netto 1077,48 brutto		P	
	14	902 netto 1109,46 brutto	1047 netto 1287,81 brutto	1298 netto 1596,54 brutto	tylko w M 569 netto 699,87 brutto		839 netto 1031,97 brutto	tylko w YN 899 netto 1105,77 brutto		P	
DREWNO	14	1103 netto 1356,69 brutto	1262 netto 1552,26 brutto	1539 netto 1892,97 brutto	tylko w M		1031 netto 1268,13 brutto	tylko w YN		P	
EMALIA	ZP				887 netto 1091,01 brutto	1100 netto 1353,00 brutto					
DREWNO	14	1111 netto 1366,53 brutto	1270 netto 1562,10 brutto	1547 netto 1902,81 brutto	tylko w M		1039 netto 1277,97 brutto	tylko w YN		P	
EMALIA	ZP				895 netto 1100,85 brutto	1108 netto 1362,84 brutto					











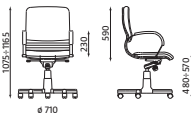

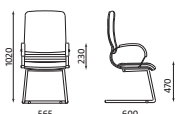

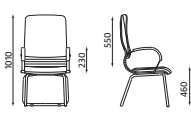

drewno: 1.007, 1.040, 1.010, 1.008, 1.016, 1.042, 1.023, 1.031, 1.033, 1.043  
emalia: 3.097

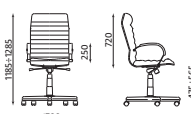
oferta: P – premium, S – standard, EX – express

TERMIN REALIZACJI podano w dniach kalendarzowych.

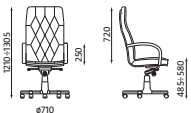
ZP – ZA POTWIERDZENIEM – oznacza każdorazowe uzgadnianie terminu realizacji z Działem Handlowym.



ważne informacje	objętość kartonu [m <sup>3</sup> ]	ilość w kartonie [szt.]	waga netto 1 szt. [kg]	siedzisko		MODEL wymiary podane w mm	 <b>GWARANCJA</b> lata <b>4</b> <small>na podzespoły mechaniczne</small>
				szer. [mm]	głęb. [mm]		
<b>REMODEX</b>	0,32	1	21,70	520	470	 	NOVA wood lb alu z mechanizmem Multiblock
							NOVA wood lb chrome z mechanizmem Multiblock
<b>REMODEX</b>	0,34	1	20,00	520	470	 	NOVA wood cf lb alu
							NOVA wood cf lb chrome
<b>REMODEX</b>	0,34	1	20,00	520	470	 	NOVA wood cfa lb alu
							NOVA wood cfa lb chrome
<b>REMODEX</b>	0,29	1	16,2	510	480	 	ORBIT z mechanizmem Tilt
 <b>REMODEX</b>	0,36	1	23,30	500	490	 	ORION steel chrome z mechanizmem Multiblock
<b>REMODEX</b>	0,36	1	26,00	530	480	 	PREMIER z mechanizmem Multiblock
<b>REMODEX</b>	0,33	1	25,60	530	480	 	PREMIER extra z mechanizmem Multiblock
<b>REMODEX</b>	0,32	1	23,50	540	470	 	RAPSODY steel04 chrome z mechanizmem Multiblock



Produkty posiadają Atest Badań Wytrzymałościowych.

Nowy Styl zastrzega sobie prawo do zmian: konstrukcyjnych, wymiarów, terminów dostaw; usunięcia produktów i zmian w palecie wykończeń.

SZCZEGÓŁOWE WYKOŃCZENIE	TERMIN REALIZACJI	CENA MODELU W ZALEŻNOŚCI OD WYKOŃCZENIA [zł]								OFERTA	
		SKÓRA DWOINA (SP)		SKÓRA LICOWA (SD/LE)		MICRO (M) SKAJ (V)	OBAN (EF) LUCIA (YB)	NOBLE LUX (NL) MICROFIBRA (CM) SOTI (SI)	CONTRACT (YN) NEXUS (UNY)		OXYGEN (OX)
		front tapicerowany skórą	front tapicerowany skórą	całość tapicerowana skórą							
DREWNO	14	1077 netto <b>1324,71 brutto</b>	1222 netto <b>1503,06 brutto</b>	1473 netto <b>1811,79 brutto</b>	tylko w M 860 netto <b>1057,80 brutto</b>		1014 netto <b>1247,22 brutto</b>	tylko w YN 1074 netto <b>1321,02 brutto</b>		P	
EMALIA	ZP										
DREWNO	14	1086 netto <b>1335,78 brutto</b>	1231 netto <b>1514,13 brutto</b>	1482 netto <b>1822,86 brutto</b>	tylko w M 869 netto <b>1068,87 brutto</b>		1023 netto <b>1258,29 brutto</b>	tylko w YN 1083 netto <b>1332,09 brutto</b>		P	
EMALIA	ZP										
DREWNO	14	879 netto <b>1081,17 brutto</b>	1024 netto <b>1259,52 brutto</b>	1275 netto <b>1568,25 brutto</b>	tylko w M 546 netto <b>671,58 brutto</b>		816 netto <b>1003,68 brutto</b>	tylko w YN 876 netto <b>1077,48 brutto</b>		P	
EMALIA	ZP										
DREWNO	14	902 netto <b>1109,46 brutto</b>	1047 netto <b>1287,81 brutto</b>	1298 netto <b>1596,54 brutto</b>	tylko w M 569 netto <b>699,87 brutto</b>		839 netto <b>1031,97 brutto</b>	tylko w YN 899 netto <b>1105,77 brutto</b>		P	
EMALIA	ZP										
DREWNO	14	879 netto <b>1081,17 brutto</b>	1024 netto <b>1259,52 brutto</b>	1275 netto <b>1568,25 brutto</b>	tylko w M 546 netto <b>671,58 brutto</b>		816 netto <b>1003,68 brutto</b>	tylko w YN 876 netto <b>1077,48 brutto</b>		P	
EMALIA	ZP										
DREWNO	14	902 netto <b>1109,46 brutto</b>	1047 netto <b>1287,81 brutto</b>	1298 netto <b>1596,54 brutto</b>	tylko w M 569 netto <b>699,87 brutto</b>		839 netto <b>1031,97 brutto</b>	tylko w YN 899 netto <b>1105,77 brutto</b>		P	
EMALIA	ZP										
	7	tylko w SI-21, SI-00 524 netto <b>644,52 brutto</b>								EX	
	5	tylko w SI-01 524 netto <b>644,52 brutto</b>									
	21	1107 netto <b>1361,61 brutto</b>	1306 netto <b>1606,38 brutto</b>							S	
1.007, 1.008, 1.010, 1.031	21	1183 netto <b>1455,09 brutto</b>	1362 netto <b>1675,26 brutto</b>							S	
1.007, 1.008, 1.010, 1.031	21	1183 netto <b>1455,09 brutto</b>	1362 netto <b>1675,26 brutto</b>							S	
	14	1157 netto <b>1423,11 brutto</b>	1265 netto <b>1555,95 brutto</b>	1581 netto <b>1944,63 brutto</b>			tylko w NL, CM 1088 netto <b>1338,24 brutto</b>	tylko w YN 1157 netto <b>1423,11 brutto</b>		P	











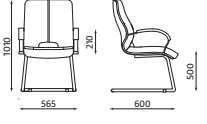

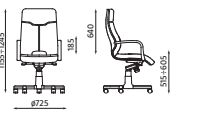

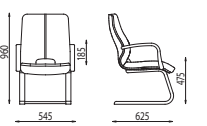

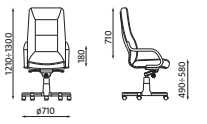

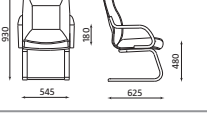



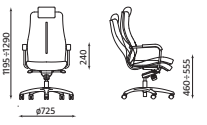

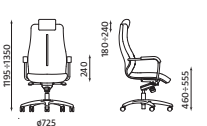

drewno: 1.007, 1.040, 1.010, 1.008, 1.016, 1.042, 1.023, 1.031, 1.033, 1.043  
emalia: 3.097

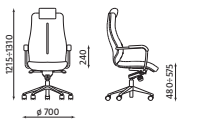
oferta: P – premium, S – standard, EX – express

TERMIN REALIZACJI podano w dniach kalendarzowych.

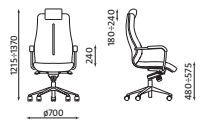
ZP – ZA POTWIERDZENIEM – oznacza każdorazowe uzgadnianie terminu realizacji z Działem Handlowym.



ważne informacje	objętość kartonu [m <sup>3</sup> ]	ilość w kartonie [szt.]	waga netto 1 szt. [kg]	siedzisko		MODEL wymiary podane w mm	 <b>2</b> lata na produkt <b>GWARANCJA</b> <b>lata</b> <b>4</b> <small>na podzespoły pneumatyczne</small>
				szer. [mm]	głęb. [mm]		
<b>REMODEX</b>	0,30	1	19,80	540	485	 	RAPSODY steel cf lb chrome
<b>REMODEX</b>	0,32	1	24,50	540	470	 	RAPSODY extra z mechanizmem Multiblock
<b>REMODEX</b>	0,29	1	15,00	540	485	 	RAPSODY extra cf lb
<b>REMODEX</b>	0,34	1	25,00	525	485	 	SENATOR z mechanizmem Multiblock
<b>REMODEX</b>	0,31	1	17,50	525	530	 	SENATOR cf lb
 <b>REMODEX</b> 	0,33	1	24,50	540	510	 	SONATA 24/7 steel17 chrome z mechanizmem Duetto Multiblock
 <b>REMODEX</b> 	0,33	1	24,50	540	510	 	SONATA HRA 24/7 steel17 chrome z mechanizmem Duetto Multiblock
<b>REMODEX</b> 	0,33	1	24,50	540	510	 	SONATA LUX steel28 chrome z mechanizmem Multiblock
  <b>REMODEX</b>	0,33	1	24,50	540	510	 	SONATA LUX HRA steel28 chrome z mechanizmem Multiblock
<b>REMODEX</b> 	0,33	1	20,00	515	460	 	SONATA LUX synchro R15 steel28 chrome z mechanizmem Epron Synchron



SZCZEGÓŁOWE WYKOŃCZENIE	TERMIN REALIZACJI	CENA MODELU W ZALEŻNOŚCI OD WYKOŃCZENIA [zł]							OFERTA	
		SKÓRA DWOINA (SP)	SKÓRA LICOWA (SD/LE)		MICRO (M) SKAJ (V)	OBAN (EF) LUCIA (YB)	NOBLE LUX (NL) MICROFIBRA (CM) SOTI (SI)	CONTRACT (YN) NEXUS (UNY)		OXYGEN (OX)
		front tapicerowany skórą	front tapicerowany skórą	całość tapicerowana skórą						
	14	831 netto <b>1022,13 brutto</b>	915 netto <b>1125,45 brutto</b>	1145 netto <b>1408,35 brutto</b>			tylko w NL, CM 776 netto <b>954,48 brutto</b>	tylko w YN 831 netto <b>1022,13 brutto</b>		P
DREWNO	14	1157 netto <b>1423,11 brutto</b>	1265 netto <b>1555,95 brutto</b>	1581 netto <b>1944,63 brutto</b>			tylko w NL, CM 1088 netto <b>1338,24 brutto</b>	tylko w YN 1157 netto <b>1423,11 brutto</b>		P
EMALIA	ZP									
DREWNO	14	831 netto <b>1022,13 brutto</b>	915 netto <b>1125,45 brutto</b>	1145 netto <b>1408,35 brutto</b>			tylko w NL, CM 776 netto <b>954,48 brutto</b>	tylko w YN 831 netto <b>1022,13 brutto</b>		P
EMALIA	ZP									
DREWNO	14	1038 netto <b>1276,74 brutto</b>	1209 netto <b>1487,07 brutto</b>				1026 netto <b>1261,98 brutto</b>			P
DREWNO	14	990 netto <b>1217,70 brutto</b>	1160 netto <b>1426,80 brutto</b>				980 netto <b>1205,40 brutto</b>			P
	21	tylko w tapicerce 24/7 (WK) o podwyższonej wytrzymałości 1653 netto <b>2033,19 brutto</b>								P
	21	tylko w tapicerce 24/7 (WK) o podwyższonej wytrzymałości 1764 netto <b>2169,72 brutto</b>								P
	21	1292 netto <b>1589,16 brutto</b>	1421 netto <b>1747,83 brutto</b>	1642 netto <b>2019,66 brutto</b>			tylko w NL, CM 1221 netto <b>1501,83 brutto</b>	tylko w YN 1290 netto <b>1586,70 brutto</b>		P
	21	1400 netto <b>1722,00 brutto</b>	1530 netto <b>1881,90 brutto</b>	1751 netto <b>2153,73 brutto</b>			tylko w NL, CM 1330 netto <b>1635,90 brutto</b>	tylko w YN 1399 netto <b>1720,77 brutto</b>		P
	21	1292 netto <b>1589,16 brutto</b>	1421 netto <b>1747,83 brutto</b>	1642 netto <b>2019,66 brutto</b>			tylko w NL, CM 1226 netto <b>1507,98 brutto</b>	tylko w YN 1290 netto <b>1586,70 brutto</b>		P













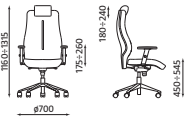

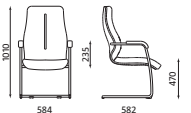

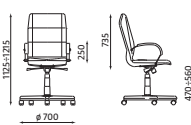
drewno: 1.007, 1.040, 1.010, 1.008, 1.016, 1.042, 1.023, 1.031, 1.033, 1.043  
emalia: 3.097

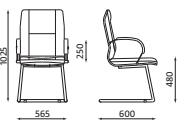
oferta: P – premium, S – standard, EX – express

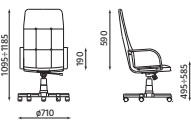
TERMIN REALIZACJI podano w dniach kalendarzowych.  
ZP – ZA POTWIERDZENIEM – oznacza każdorazowe uzgadnianie terminu realizacji z Działem Handlowym.

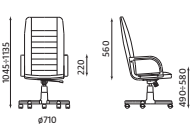

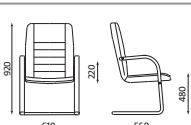











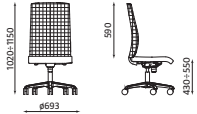

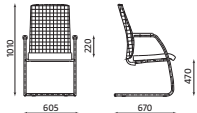

ważne informacje	objętość kartonu [m <sup>3</sup> ]	ilość w kartonie [szt.]	waga netto 1 szt. [kg]	siedzisko		MODEL wymiary podane w mm	
				szer. [mm]	głęb. [mm]		
 <b>REMODEX</b>	0,33	1	20,00	515	460	 	SONATA LUX HRA synchro R15 steel28 chrome z mechanizmem Epron Synchron
 	0,50	1	17,00	540	510	 	SONATA LUX cf lb steel chrome
<b>REMODEX</b>	0,33	1	22,00	510	460	 	STAR steel chrome z mechanizmem Multiblock
<b>REMODEX</b>	0,34	1	18,10	510	460	 	STAR steel cf lb chrome
<b>REMODEX</b>	0,30	1	19,00	505	465	 	ZENIT steel04 z mechanizmem Tilt
<b>REMODEX</b>	0,30	1	20,40	535	460	 	ZORBA extra z mechanizmem Tilt
<b>REMODEX</b>	0,30	1	20,70	535	460	 	ZORBA extra cfn/lb
							WIESZAK fotelowy

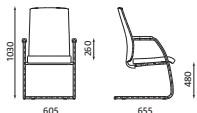

SZCZEGÓLNE WYKOŃCZENIE	TERMIN REALIZACJI	CENA MODELU W ZALEŻNOŚCI OD WYKOŃCZENIA [zł]							OFERTA	
		SKÓRA DWOINA (SP)	SKÓRA LICOWA (SD/LE)		MICRO (M) SKAJ (V)	OBAN (EF) LUCIA (YB)	NOBLE LUX (NL) MICROFIBRA (CM) SOTI (SI)	CONTRACT (YN) NEXUS (UNY)		OXYGEN (OX)
		front tapicerowany skórą	front tapicerowany skórą	całość tapicerowana skórą						
	21	1400 netto <b>1722,00 brutto</b>	1530 netto <b>1881,90 brutto</b>	1751 netto <b>2153,73 brutto</b>			tylko w NL, CM 1330 netto <b>1635,90 brutto</b>	tylko w YN 1399 netto <b>1720,77 brutto</b>	P	
	21	891 netto <b>1095,93 brutto</b>	991 netto <b>1218,93 brutto</b>	1151 netto <b>1415,73 brutto</b>			tylko w NL, CM 825 netto <b>1014,75 brutto</b>	tylko w YN 889 netto <b>1093,47 brutto</b>	P	
	21	1070 netto <b>1316,10 brutto</b>	1241 netto <b>1526,43 brutto</b>	1491 netto <b>1833,93 brutto</b>			tylko w NL, CM 994 netto <b>1222,62 brutto</b>	tylko w YN 1066 netto <b>1311,18 brutto</b>	P	
	21	839 netto <b>1031,97 brutto</b>	1012 netto <b>1244,76 brutto</b>	1222 netto <b>1503,06 brutto</b>			tylko w NL, CM 770 netto <b>947,10 brutto</b>	tylko w YN 834 netto <b>1025,82 brutto</b>	P	
	21	661 netto <b>813,03 brutto</b>	776 netto <b>954,48 brutto</b>						S	
1.007, 1.008, 1.010, 1.031	14	780 netto <b>959,40 brutto</b>	912 netto <b>1121,76 brutto</b>		tylko w M 688 netto <b>846,24 brutto</b>				S	
1.007, 1.008, 1.010, 1.031	14	727 netto <b>894,21 brutto</b>	852 netto <b>1047,96 brutto</b>		tylko w M 647 netto <b>795,81 brutto</b>				S	
		84 netto <b>103,32 brutto</b> Dostępny tylko z fotelami: ARTUS, ELF, FORMULA, GALAXY, INVITUS, METEOR, NEO LUX PL, NOVA, ORION, RAPSODY, SONATA, STAR (tylko z wysokimi wersjami obrotowymi, nie dostępny dla wersji obrotowych lb i wersji na płozie).							P	

oferta: P – premium, S – standard, EX – express

ważne informacje	objętość kartonu [m <sup>3</sup> ]	ilość w kartonie [szt.]	waga netto 1 szt. [kg]	siedzisko		MODEL wymiary podane w mm	
				szer. [mm]	głęb. [mm]		
	0,185	1	16,20	480	400	 	SIT.NET gts ts16 z mechanizmem Epron Synchron
	0,45	1	13,90	480	400	 	SIT.NET cf chrome
 	0,185	1	16,70	480	400	 	SIT.ON gts ts16 z mechanizmem Epron Synchron
 	0,45	1	14,20	480	400	 	SIT.ON cf chrome

400-460	podstawa krzesła	kombinacja polerowanego i malowanego na biało aluminium [steel36 CR]
	podfokietniki	regulowane w pozycji góra/dół z miękkimi nakładkami [R19I]
		regulowane w pozycji góra/dół z miękkimi nakładkami i dodatkową możliwością regulacji pozycji nakładek [R15K chrome]
	mechanizm	Epron Synchron z regulacją głębokości siedziska [EST]
	zagłówek	tapicerowany, regulowany w dwóch wymiarach [HRU]
podparcie lędźwi	dostępne podparcie lędźwi dla krzesła SIT.NET [LU]	



TERMIN REALIZACJI	CENA MODELU W ZALEŻNOŚCI OD WYKOŃCZENIA [zł]					OFERTA
	SKÓRA LICOWA (SD/LE)	OBAN (EF) LUCIA (YB)	SOTI (SI)	CONTRACT (YN)	OXYGEN (OX)	
14	896 netto <b>1102,08 brutto</b>	756 netto <b>929,88 brutto</b>	799 netto <b>982,77 brutto</b>	817 netto <b>1004,91 brutto</b>	846 netto <b>1040,58 brutto</b>	P
14	1051 netto <b>1292,73 brutto</b>	911 netto <b>1120,53 brutto</b>	954 netto <b>1173,42 brutto</b>	972 netto <b>1195,56 brutto</b>	999 netto <b>1228,77 brutto</b>	P
14		812 netto <b>998,76 brutto</b>	847 netto <b>1041,81 brutto</b>	885 netto <b>1088,55 brutto</b>	929 netto <b>1142,67 brutto</b>	P
14		979 netto <b>1204,17 brutto</b>	994 netto <b>1222,62 brutto</b>	1032 netto <b>1269,36 brutto</b>	1078 netto <b>1325,94 brutto</b>	P

## CENA DODATKÓW (dopłata do wersji podstawowych) [zł]

120 netto  
**147,60 brutto**

89 netto  
**109,47 brutto**

160 netto  
**196,80 brutto**

72 netto  
**88,56 brutto**

tylko w LE  
109 netto  
**134,07 brutto**

85 netto  
**104,55 brutto**

















86 netto  
**105,78 brutto**

91 netto  
**111,93 brutto**

94 netto  
**115,62 brutto**

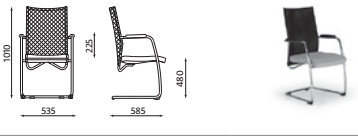
64 netto  
**78,72 brutto**

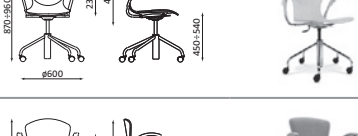
oferta: P – premium, S – standard, EX – express

ważne informacje	objętość kartonu [m <sup>3</sup> ]	ilość w kartonie [szt.]	waga netto 1 szt. [kg]	siedzisko		MODEL wymiary podane w mm	 <b>2</b> lata na produkt <b>GWARANCJA</b> <b>lata</b> na podłożach <b>4</b> płynności
				szer. [mm]	głęb. [mm]		
 <b>REMODEX</b>	0,25	1	18,00	455	400÷460		@-MOTION R15K steel33 chrome z mechanizmem Epron Synchron i regulacją głębokości siedziska
 <b>REMODEX</b>	0,32	1	18,40	455	400÷460		@-MOTION R15K HR steel33 chrome z mechanizmem Epron Synchron i regulacją głębokości siedziska
 <b>REMODEX</b>	0,32	1	18,40	455	400÷460		@-MOTION R15K HRU steel33 chrome z mechanizmem Epron Synchron i regulacją głębokości siedziska
 <b>REMODEX</b>	0,25	1	18,00	455	400÷460		@-MOTION U R15K steel33 chrome z mechanizmem Epron Synchron i regulacją głębokości siedziska
<b>REMODEX</b>	0,30	1	18,40	455	400÷460		@-MOTION U R15K HRU steel33 chrome z mechanizmem Epron Synchron i regulacją głębokości siedziska
<b>REMODEX</b>	0,25	1	18,00	455	420		@-MOTION R18K steel33 chrome Ring Base z mechanizmem Epron Synchron
	0,40	1	10,00	455	465		@-MOTION cfp lux chrome
<b>REMODEX</b>	0,12	1	8,80	460	460		AMIGO gtp chrome
<b>REMODEX</b>	0,19	1	11,30	445	455		BINGO wood gtp chrome
<b>REMODEX</b>	0,19	1	12,00	445	455		BINGO wood plus gtp chrome



SZCZEGÓLNE WYKOŃCZENIE	TERMIN REALIZACJI	CENA MODELU W ZALEŻNOŚCI OD WYKOŃCZENIA [zł]							OFERTA
		SKÓRA DWOINA (SP)	SKÓRA LICOWA (SD/LE)	TAPICERKA PODSTAWOWA (C) MICRO (M) SKAJ (V)	OBAN (EF) LUCIA (YB)	NOBLE LUX (NL) MICROFIBRA (CM) SOTI (SI)	CONTRACT (YN) NEXUS (UNY)	OXYGEN (OX)	
		front tapicerowany skórą	front tapicerowany skórą						
	14		1305 netto 1605,15 brutto	tylko w M 1156 netto 1421,88 brutto	1172 netto 1441,56 brutto	1184 netto 1456,32 brutto	1204 netto 1480,92 brutto	1234 netto 1517,82 brutto	P
	14		1331 netto 1637,13 brutto	tylko w M 1182 netto 1453,86 brutto	1198 netto 1473,54 brutto	1210 netto 1488,30 brutto	1230 netto 1512,90 brutto	1260 netto 1549,80 brutto	P
	14		1367 netto 1681,41 brutto	tylko w M 1206 netto 1483,38 brutto	1223 netto 1504,29 brutto	1237 netto 1521,51 brutto	1256 netto 1544,88 brutto	1287 netto 1583,01 brutto	P
	14		1413 netto 1737,99 brutto						P
	14		1475 netto 1814,25 brutto						P
	14		1259 netto 1548,57 brutto	tylko w M 1110 netto 1365,30 brutto	1127 netto 1386,21 brutto	tylko w NL, CM 1139 netto 1400,97 brutto	1158 netto 1424,34 brutto	1188 netto 1461,24 brutto	P
	14		799 netto 982,77 brutto	tylko w M 705 netto 867,15 brutto	722 netto 888,06 brutto	tylko w NL, CM 733 netto 901,59 brutto	743 netto 913,89 brutto	774 netto 952,02 brutto	P
K02, K05, K32, K36, K53, K30, K31, K33, K35, K59, K51, K01	ZP				319 netto 392,37 brutto				P
DREWNO	14				531 netto 653,13 brutto				P
DREWNO	14				567 netto 697,41 brutto	574 netto 706,02 brutto	579 netto 712,17 brutto	587 netto 722,01 brutto	P













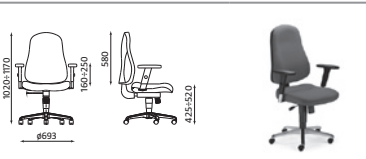

drewno: 1.007, 1.040, 1.010, 1.008, 1.016, 1.042, 1.023, 1.031, 1.033, 1.043

oferta: P – premium, S – standard, EX – express

TERMIN REALIZACJI podano w dniach kalendarzowych.

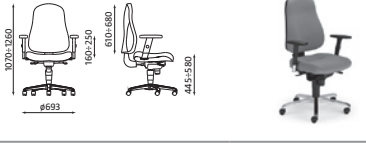
ZP – ZA POTWIERDZENIEM – oznacza każdorazowe uzgadnianie terminu realizacji z Działem Handlowym.

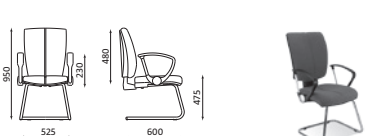

ważne informacje	objętość kartonu [m <sup>3</sup> ]	ilość w kartonie [szt.]	waga netto 1 szt. [kg]	siedzisko		MODEL wymiary podane w mm	 <b>2</b> lata na produkt <b>GWARANCJA</b> <b>lata</b> na podłożach <b>4</b> płynności
				szer. [mm]	głęb. [mm]		
 <b>REMODOX</b>	0,185	1	18,00	475	350		BIZZI gts steel36 chrome z mechanizmem Active IN
 	0,183	1	20,00	475	350		BIZZI gtp42 steel36 chrome z mechanizmem Active IN
 	0,183	1	20,00	475	350		BIZZI R15K steel36 chrome z mechanizmem Active IN
 <b>DLUŻSZA GWARANCJA</b>	0,183	1	20,00	475	400÷470		BIZZI gtp42 steel36 chrome z mechanizmem Epron Synchron i regulacją głębokości siedziska
 <b>DLUŻSZA GWARANCJA</b>	0,183	1	20,00	475	400÷470		BIZZI R15K steel36 chrome z mechanizmem Epron Synchron i regulacją głębokości siedziska
	0,16	1	18,00	480	470		BOLERO II R1B ts06 z mechanizmem Epron Synchron
<b>REMODOX</b>	0,16	1	18,00	480	470		BOLERO II R1B steel02 chrome z mechanizmem Epron Synchron
<b>REMODOX</b> <b>DLUŻSZA GWARANCJA</b>	0,16	1	18,00	510	395÷445		CINQUE R2C steel12 chrome z mechanizmem Imarc-840
<b>REMODOX</b> <b>DLUŻSZA GWARANCJA</b>	0,16	1	17,00	510	395÷445		CINQUE gtp9 steel12 chrome z mechanizmem Imarc-840
<b>REMODOX</b> <b>DLUŻSZA GWARANCJA</b>	0,17	1	12,75	510	400÷440		CINQUE cfp chrome















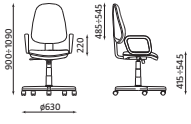

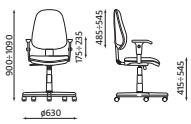

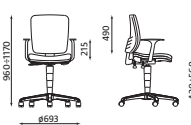

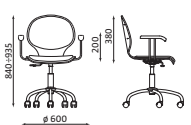

SZCZEGÓLNE WYKOŃCZENIE	TERMIN REALIZACJI	CENA MODELU W ZALEŻNOŚCI OD WYKOŃCZENIA [zł]							OFERTA
		SKÓRA DWOINA (SP)	SKÓRA LICOWA (SD/LE)	TAPICERKA PODSTAWOWA (C) MICRO (M) SKAJ (V)	OBAN (EF) LUCIA (YB)	NOBLE LUX (NL) MICROFIBRA (CM) SOTI (SI)	CONTRACT (YN) NEXUS (UNY)	OXYGEN (OX)	
		front tapicerowany skórą	front tapicerowany skórą						
	14			tylko w M 577 netto <b>709,71 brutto</b>	599 netto <b>736,77 brutto</b>		637 netto <b>783,51 brutto</b>	662 netto <b>814,26 brutto</b>	P
	14			tylko w M 615 netto <b>756,45 brutto</b>	637 netto <b>783,51 brutto</b>		675 netto <b>830,25 brutto</b>	700 netto <b>861,00 brutto</b>	P
	14			tylko w M 769 netto <b>945,87 brutto</b>	791 netto <b>972,93 brutto</b>		829 netto <b>1019,67 brutto</b>	854 netto <b>1050,42 brutto</b>	P
	14			tylko w M 798 netto <b>981,54 brutto</b>	821 netto <b>1009,83 brutto</b>		858 netto <b>1055,34 brutto</b>	884 netto <b>1087,32 brutto</b>	P
	14			tylko w M 949 netto <b>1167,27 brutto</b>	970 netto <b>1193,10 brutto</b>		1006 netto <b>1237,38 brutto</b>	1033 netto <b>1270,59 brutto</b>	P
	21			tylko w M 596 netto <b>733,08 brutto</b>	696 netto <b>856,08 brutto</b>	736 netto <b>905,28 brutto</b>	786 netto <b>966,78 brutto</b>		P
	21			tylko w M 656 netto <b>806,88 brutto</b>	757 netto <b>931,11 brutto</b>	796 netto <b>979,08 brutto</b>	846 netto <b>1040,58 brutto</b>		P
	14			tylko w M 950 netto <b>1168,50 brutto</b>	952 netto <b>1170,96 brutto</b>		998 netto <b>1227,54 brutto</b>		P
	14			tylko w M 851 netto <b>1046,73 brutto</b>	853 netto <b>1049,19 brutto</b>		899 netto <b>1105,77 brutto</b>		P
	14			tylko w M 457 netto <b>562,11 brutto</b>	459 netto <b>564,57 brutto</b>		503 netto <b>618,69 brutto</b>		P

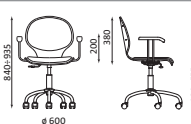
oferta: P – premium, S – standard, EX – express

TERMIN REALIZACJI podano w dniach kalendarzowych.

ZP – ZA POTWIERDZENIEM – oznacza każdorazowe uzgadnianie terminu realizacji z Działem Handlowym.

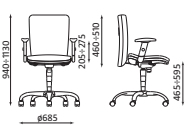

ważne informacje	objętość kartonu [m <sup>3</sup> ]	ilość w kartonie [szt.]	waga netto 1 szt. [kg]	siedzisko		MODEL wymiary podane w mm	 <b>GWARANCJA</b> <b>lata</b> <b>4</b> <small>na podnośnik pneumatyczny</small>
				szer. [mm]	głęb. [mm]		
<b>REMODEX</b>							<b>CINQUE 4L</b>
<b>REMODEX</b>	0,15	1	15,00	465	440		 <b>COMFORT profil gtp</b> z mechanizmem Active-1  <b>COMFORT gtp</b> z mechanizmem Active-1 i Schukra
			15,30				
<b>REMODEX</b>	0,15	1	15,50	465	440		 <b>COMFORT profil R</b> z mechanizmem Active-1  <b>COMFORT R</b> z mechanizmem Active-1 i Schukra
			15,80				
 <b>REMODEX</b>	0,185	1	13,00	470	460		 <b>DROP gtp46 ts16</b> z mechanizmem Ergon UP
 <b>REMODEX</b>	0,185	1	13,00	470	460		 <b>DROP R27 ts16</b> z mechanizmem Ergon UP
<b>REMODEX</b>	0,12	1	8,75	470	430		 <b>ESPRESSO gtp chrome</b>
<b>REMODEX</b>	0,12	1	9,65	470	430		 <b>ESPRESSO gtp plus chrome</b>
 <b>REMODEX</b>	0,18	1	15,60	470	455		 <b>EXTREME II R1B</b> z mechanizmem Epron Synchron
 <b>REMODEX</b>	0,18	1	16,60	470	455		 <b>EXTREME II R1B steel02 chrome</b> z mechanizmem Epron Synchron  <b>EXTREME II R1W steel02 chrome</b> z mechanizmem Epron Synchron



Produkty posiadają Atest Badań Wytrzymałościowych.

Nowy Styl zastrzega sobie prawo do zmian: konstrukcyjnych, wymiarów, terminów dostaw; usunięcia produktów i zmian w palecie wykończeń.

SZCZEGÓLNE WYKOŃCZENIE	TERMIN REALIZACJI	CENA MODELU W ZALEŻNOŚCI OD WYKOŃCZENIA [zł]							OFERTA
		SKÓRA DWOINA (SP)	SKÓRA LICOWA (SD/LE)	TAPICERKA PODSTAWOWA (C) MICRO (M) SKAJ (V)	OBAN (EF) LUCIA (YB)	NOBLE LUX (NL) MICROFIBRA (CM) SOTI (SI)	CONTRACT (YN) NEXUS (UNY)	OXYGEN (OX)	
		front tapicerowany skórą	front tapicerowany skórą						

ceny dotyczące krzesła CINQUE 4L na stronie 60

	21			tylko w C, M 378 netto <b>464,94 brutto</b>	397 netto <b>488,31 brutto</b>	tylko w SI 414 netto <b>509,22 brutto</b>			P
	21			tylko w C, M 492 netto <b>605,16 brutto</b>	512 netto <b>629,76 brutto</b>	tylko w SI 529 netto <b>650,67 brutto</b>			P
	21			tylko w C, M 418 netto <b>514,14 brutto</b>	438 netto <b>538,74 brutto</b>	tylko w SI 456 netto <b>560,88 brutto</b>			P
	21			tylko w C, M 533 netto <b>655,59 brutto</b>	552 netto <b>678,96 brutto</b>	tylko w SI 570 netto <b>701,10 brutto</b>			P
	14			również w CU 377 netto <b>463,71 brutto</b>	tylko w EF 398 netto <b>489,54 brutto</b>				S
	14			również w CU 416 netto <b>511,68 brutto</b>	tylko w EF 440 netto <b>541,20 brutto</b>				S
DREWNO	ZP	405 netto <b>498,15 brutto</b>							P
DREWNO	ZP			431 netto <b>530,13 brutto</b>	441 netto <b>542,43 brutto</b>	448 netto <b>551,04 brutto</b>	453 netto <b>557,19 brutto</b>		P
	14			tylko w M 647 netto <b>795,81 brutto</b>	695 netto <b>854,85 brutto</b>	tylko w NL 718 netto <b>883,14 brutto</b>	743 netto <b>913,89 brutto</b>		P
	14			tylko w M 704 netto <b>865,92 brutto</b>	753 netto <b>926,19 brutto</b>	tylko w NL 776 netto <b>954,48 brutto</b>	802 netto <b>986,46 brutto</b>		P
DREWNO	14			tylko w M 724 netto <b>890,52 brutto</b>	771 netto <b>948,33 brutto</b>	tylko w NL 795 netto <b>977,85 brutto</b>	819 netto <b>1007,37 brutto</b>		P
EMALIA	ZP								P











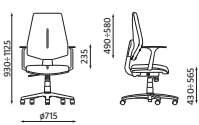



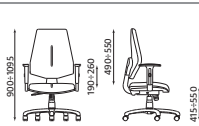

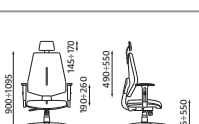

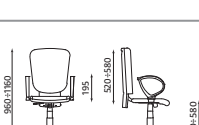

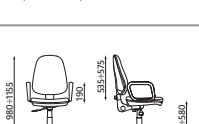
drewno: 1.007, 1.040, 1.010, 1.008, 1.016, 1.042, 1.023, 1.031, 1.033, 1.043  
emalia: 3.097

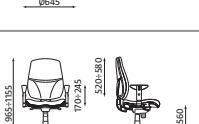
oferta: P – premium, S – standard, EX – express

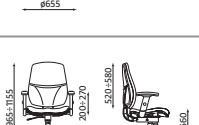
TERMIN REALIZACJI podano w dniach kalendarzowych.

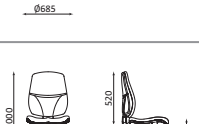
ZP – ZA POTWIERDZENIEM – oznacza każdorazowe uzgadnianie terminu realizacji z Działem Handlowym.

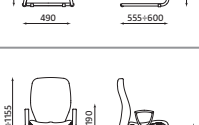

ważne informacje	objętość kartonu [m <sup>3</sup> ]	ilość w kartonie [szt.]	waga netto 1 szt. [kg]	siedzisko		MODEL wymiary podane w mm	
				szer. [mm]	głęb. [mm]		
<b>DLUŻSZA GWARANCJA</b>	0,18	1	15,80	510	420	 	GEM gtp46 ts06 z mechanizmem Active-1
<b>DLUŻSZA GWARANCJA</b>	0,21	1	16,10	510	420	 	GEM HR gtp46 ts06 z mechanizmem Active-1
<b>DLUŻSZA GWARANCJA</b>	0,18	1	15,80	510	420	 	GEM R26S steel04 chrome z mechanizmem Active-1
<b>DLUŻSZA GWARANCJA</b>	0,21	1	16,10	510	420	 	GEM HR R26S steel04 chrome z mechanizmem Active-1
<b>REMODEX</b>	0,26	1	12,80	460	440	 	GENER@TION 10 gtp30 z mechanizmem Active-1
<b>REMODEX</b>	0,10	1	15,40	460	415÷450	 	GRAND gtp5 profil ts02 z mechanizmem CPT
<b>REMODEX</b>	0,162	1	16,00	495	420	 	INSPIRE R10 steel02 chrome z mechanizmem Active-1
<b>REMODEX</b>	0,15	1	16,00	495	420	 	INSPIRE R1C steel02 chrome z mechanizmem Active-1
	0,16	1	8,30	495	410÷455	 	INSPIRE cfs chrome
<b>REMODEX</b>	0,18	1	17,50	500	450	 	JUMP gtp8 ts06 z mechanizmem Epron Synchron



Produkty posiadają Atest Badań Wytrzymałościowych.

Nowy Styl zastrzega sobie prawo do zmian: konstrukcyjnych, wymiarów, terminów dostaw; usunięcia produktów i zmian w paletce wykończeń.













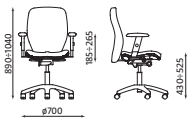

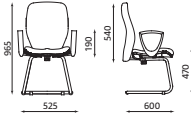





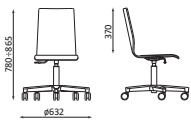

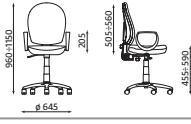







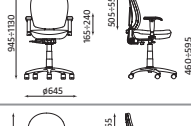

SZCZEGÓLNE WYKOŃCZENIE	TERMIN REALIZACJI	CENA MODELU W ZALEŻNOŚCI OD WYKOŃCZENIA [zł]							OFERTA
		SKÓRA DWOINA (SP)	SKÓRA LICOWA (SD/LE)	TAPICERKA PODSTAWOWA (C) MICRO (M) SKAJ (V)	OBAN (EF) LUCIA (YB)	NOBLE LUX (NL) MICROFIBRA (CM) SOTI (SI)	CONTRACT (YN) NEXUS (UNY)	OXYGEN (OX)	
		front tapicerowany skórą	front tapicerowany skórą						
	21			tylko w M 481 netto <b>591,63 brutto</b>	498 netto <b>612,54 brutto</b>		550 netto <b>676,50 brutto</b>	590 netto <b>725,70 brutto</b>	P
	21			tylko w M 567 netto <b>697,41 brutto</b>	586 netto <b>720,78 brutto</b>		645 netto <b>793,35 brutto</b>	685 netto <b>842,55 brutto</b>	P
	21			tylko w M 602 netto <b>740,46 brutto</b>	619 netto <b>761,37 brutto</b>		670 netto <b>824,10 brutto</b>	710 netto <b>873,30 brutto</b>	P
	21			tylko w M 688 netto <b>846,24 brutto</b>	707 netto <b>869,61 brutto</b>		765 netto <b>940,95 brutto</b>	805 netto <b>990,15 brutto</b>	P
	21			tylko w M 462 netto <b>568,26 brutto</b>	tylko w EF 503 netto <b>618,69 brutto</b>				S
	14			również w CU 226 netto <b>277,98 brutto</b>	tylko w EF 248 netto <b>305,04 brutto</b>				S
	14			tylko w C, M 540 netto <b>664,20 brutto</b>	560 netto <b>688,80 brutto</b>		602 netto <b>740,46 brutto</b>	622 netto <b>765,06 brutto</b>	P
	14			tylko w C, M 563 netto <b>692,49 brutto</b>	581 netto <b>714,63 brutto</b>		622 netto <b>765,06 brutto</b>	642 netto <b>789,66 brutto</b>	P
	14			tylko w C, M 318 netto <b>391,14 brutto</b>	337 netto <b>414,51 brutto</b>		378 netto <b>464,94 brutto</b>	398 netto <b>489,54 brutto</b>	P
	14			tylko w M 646 netto <b>794,58 brutto</b>	655 netto <b>805,65 brutto</b>	688 netto <b>846,24 brutto</b>	730 netto <b>897,90 brutto</b>	762 netto <b>937,26 brutto</b>	P

oferta: P – premium, S – standard, EX – express

TERMIN REALIZACJI podano w dniach kalendarzowych.

ZP – ZA POTWIERDZENIEM – oznacza każdorazowe uzgadnianie terminu realizacji z Działem Handlowym.

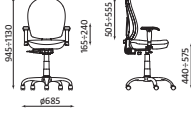

ważne informacje	objętość kartonu [m <sup>3</sup> ]	ilość w kartonie [szt.]	waga netto 1 szt. [kg]	siedzisko		MODEL wymiary podane w mm	
				szer. [mm]	głęb. [mm]		
<b>REMODEX</b> 	0,18	1	19,50	500	450	 	JUMP R15G steel28 chrome z mechanizmem Tatto
<b>REMODEX</b> 	0,226	1	14,00	500	435÷475	 	JUMP cfp chrome
	0,19	1	7,00	395	460	 	LATTE gts steel 23 chrome
	0,19	1	7,00	395	460	 	LATTE gts steel 23 plus chrome
<b>REMODEX</b> 	0,125	1	12,20	485	385÷425	 	MIND gtp7 z mechanizmem CPT
<b>REMODEX</b>	0,125	1	13,00	485	400÷420	 	MIND gtp7 z mechanizmem Kontakt
<b>REMODEX</b> 	0,146	1	14,20	485	420	 	MIND gtp7 z mechanizmem Active-1
<b>REMODEX</b> 	0,125	1	12,70	485	385÷425	 	MIND R2E z mechanizmem CPT
<b>REMODEX</b>	0,125	1	12,70	485	400÷420	 	MIND R2E z mechanizmem Kontakt
<b>REMODEX</b> 	0,146	1	14,70	485	420	 	MIND R2E z mechanizmem Active-1
<b>REMODEX</b> 	0,146	1	15,20	485	420	 	MIND gtp7 steel02 chrome z mechanizmem Active-1
<b>REMODEX</b> 	0,146	1	14,10	485	420	 	MIND R2E steel02 chrome z mechanizmem Active-1



SZCZEGÓLWE WYKOŃCZENIE	TERMIN REALIZACJI	CENA MODELU W ZALEŻNOŚCI OD WYKOŃCZENIA [zł]							OFERTA
		SKÓRA DWOINA (SP)	SKÓRA LICOWA (SD/LE)	TAPICERKA PODSTAWOWA (C) MICRO (M) SKAJ (V)	OBAN (EF) LUCIA (YB)	NOBLE LUX (NL) MICROFIBRA (CM) SOTI (SI)	CONTRACT (YN) NEXUS (UNY)	OXYGEN (OX)	
		front tapicerowany skórą	front tapicerowany skórą						
	14			tylko w M 879 netto <b>1081,17 brutto</b>	888 netto <b>1092,24 brutto</b>	921 netto <b>1132,83 brutto</b>	963 netto <b>1184,49 brutto</b>	995 netto <b>1223,85 brutto</b>	P
	14			tylko w M 473 netto <b>581,79 brutto</b>	481 netto <b>591,63 brutto</b>	515 netto <b>633,45 brutto</b>	556 netto <b>683,88 brutto</b>	587 netto <b>722,01 brutto</b>	P
DREWNO	14	395 netto <b>485,85 brutto</b>							P
LAMINAT	14	438 netto <b>538,74 brutto</b>							P
DREWNO	14			422 netto <b>519,06 brutto</b>	432 netto <b>531,36 brutto</b>	438 netto <b>538,74 brutto</b>	444 netto <b>546,12 brutto</b>		P
	14			tylko w C, M 318 netto <b>391,14 brutto</b>	340 netto <b>418,20 brutto</b>	tylko w NL, CM 363 netto <b>446,49 brutto</b>	382 netto <b>469,86 brutto</b>		P
	14			tylko w C, M 361 netto <b>444,03 brutto</b>	384 netto <b>472,32 brutto</b>	tylko w NL, CM 407 netto <b>500,61 brutto</b>	426 netto <b>523,98 brutto</b>		P
	14			tylko w C, M 409 netto <b>503,07 brutto</b>	432 netto <b>531,36 brutto</b>	tylko w NL, CM 455 netto <b>559,65 brutto</b>	474 netto <b>583,02 brutto</b>		P
	14			tylko w C, M 388 netto <b>477,24 brutto</b>	411 netto <b>505,53 brutto</b>	tylko w NL, CM 434 netto <b>533,82 brutto</b>	453 netto <b>557,19 brutto</b>		P
	14			tylko w C, M 432 netto <b>531,36 brutto</b>	453 netto <b>557,19 brutto</b>	tylko w NL, CM 477 netto <b>586,71 brutto</b>	496 netto <b>610,08 brutto</b>		P
	14			tylko w C, M 452 netto <b>555,96 brutto</b>	476 netto <b>585,48 brutto</b>	tylko w NL, CM 499 netto <b>613,77 brutto</b>	518 netto <b>637,14 brutto</b>		P
	14			tylko w C, M 477 netto <b>586,71 brutto</b>	499 netto <b>613,77 brutto</b>	tylko w NL, CM 522 netto <b>642,06 brutto</b>	542 netto <b>666,66 brutto</b>		P
	14			tylko w C, M 522 netto <b>642,06 brutto</b>	544 netto <b>669,12 brutto</b>	tylko w NL, CM 567 netto <b>697,41 brutto</b>	587 netto <b>722,01 brutto</b>		P

drewno: 1.007, 1.040, 1.010, 1.008, 1.016, 1.042, 1.023, 1.031, 1.033, 1.043

















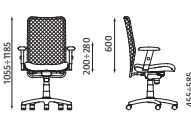

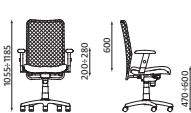

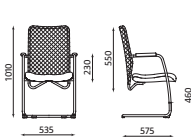

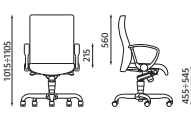
laminat: H1733, H3389, H3005, H3704, W1000, U303, U630, U321, U999, U773, H3005 horizontal

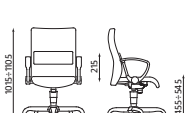
oferta: P – premium, S – standard, EX – express

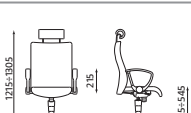
TERMIN REALIZACJI podano w dniach kalendarzowych.

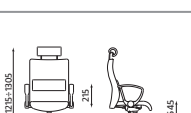
ZP – ZA POTWIERDZENIEM – oznacza każdorazowe uzgadnianie terminu realizacji z Działem Handlowym.



ważne informacje	objętość kartonu [m <sup>3</sup> ]	ilość w kartonie [szt.]	waga netto 1 szt. [kg]	siedzisko		MODEL wymiary podane w mm	
				szer. [mm]	głęb. [mm]		
 <b>REMODEX</b>	0,21	9	15,00	485	420	 	MONTANA HB LU R15G steel11 chrome z mechanizmem Epron Synchron Plus
			16,90		420÷480	 	MONTANA HB LU R15G steel11 chrome z mechanizmem Epron Synchron Plus i regulacją głębokości siedziska
<b>REMODEX</b>	0,15	1	15,30	485	420	 	MONTANA R15G steel11 chrome z mechanizmem Epron Synchron
<b>REMODEX</b>	0,15	1	16,50	485	420÷480	 	MONTANA R15G steel11 chrome z mechanizmem Epron Synchron i regulacją głębokości siedziska
<b>REMODEX</b>	0,40	1	16,00	470	475	 	MONTANA LUX cfp chrome
<b>REMODEX</b>	0,18	1	19,00	475	460	 	NEO II gtp9 steel02 alu z mechanizmem Epron Synchron
<b>REMODEX</b>	0,18	1	19,00	475	425	 	NEO II LU gtp9 steel02 alu z mechanizmem Epron Synchron
<b>REMODEX</b>	0,21	1	18,70	475	460	 	NEO II HR gtp9 steel02 alu z mechanizmem Epron Synchron
<b>REMODEX</b>	0,21	1	18,70	475	425	 	NEO II HR LU gtp9 steel02 alu z mechanizmem Epron Synchron
<b>REMODEX</b>	0,102	1	12,44	490	440	 	NEO cfp alu



























SZCZEGÓLNE WYKOŃCZENIE	TERMIN REALIZACJI	CENA MODELU W ZALEŻNOŚCI OD WYKOŃCZENIA [zł]							OFERTA
		SKÓRA DWOINA (SP)	SKÓRA LICOWA (SD/LE)	TAPICERKA PODSTAWOWA (C) MICRO (M) SKAJ (V)	OBAN (EF) LUCIA (YB)	NOBLE LUX (NL) MICROFIBRA (CM) SOTI (SI)	CONTRACT (YN) NEXUS (UNY)	OXYGEN (OX)	
		front tapicerowany skórą	front tapicerowany skórą						
	21			tylko w M 907 netto <b>1115,61 brutto</b>	936 netto <b>1151,28 brutto</b>	tylko w NL, CM 941 netto <b>1157,43 brutto</b>	962 netto <b>1183,26 brutto</b>	982 netto <b>1207,86 brutto</b>	P
	21			tylko w M 986 netto <b>1212,78 brutto</b>	1006 netto <b>1237,38 brutto</b>	tylko w NL, CM 1012 netto <b>1244,76 brutto</b>	1032 netto <b>1269,36 brutto</b>	1052 netto <b>1293,96 brutto</b>	P
	21			tylko w M 792 netto <b>974,16 brutto</b>	821 netto <b>1009,83 brutto</b>	tylko w NL, CM 834 netto <b>1025,82 brutto</b>	847 netto <b>1041,81 brutto</b>	867 netto <b>1066,41 brutto</b>	P
	21			tylko w M 871 netto <b>1071,33 brutto</b>	891 netto <b>1095,93 brutto</b>	tylko w NL, CM 904 netto <b>1111,92 brutto</b>	917 netto <b>1127,91 brutto</b>	927 netto <b>1140,21 brutto</b>	P
	21			tylko w M 695 netto <b>854,85 brutto</b>	716 netto <b>880,68 brutto</b>	tylko w NL, CM 729 netto <b>896,67 brutto</b>	743 netto <b>913,89 brutto</b>	764 netto <b>939,72 brutto</b>	P
	21			tylko w M 696 netto <b>856,08 brutto</b>	726 netto <b>892,98 brutto</b>	tylko w NL, CM 765 netto <b>940,95 brutto</b>	800 netto <b>984,00 brutto</b>	845 netto <b>1039,35 brutto</b>	P
	21			tylko w M 711 netto <b>874,53 brutto</b>	742 netto <b>912,66 brutto</b>	tylko w NL, CM 781 netto <b>960,63 brutto</b>	815 netto <b>1002,45 brutto</b>	855 netto <b>1051,65 brutto</b>	P
	21			tylko w M 819 netto <b>1007,37 brutto</b>	860 netto <b>1057,80 brutto</b>	tylko w NL, CM 899 netto <b>1105,77 brutto</b>	936 netto <b>1151,28 brutto</b>	976 netto <b>1200,48 brutto</b>	P
	21			tylko w M 834 netto <b>1025,82 brutto</b>	875 netto <b>1076,25 brutto</b>	tylko w NL, CM 914 netto <b>1124,22 brutto</b>	951 netto <b>1169,73 brutto</b>	991 netto <b>1218,93 brutto</b>	P
	21			tylko w M 350 netto <b>430,50 brutto</b>	376 netto <b>462,48 brutto</b>	tylko w NL, CM 415 netto <b>510,45 brutto</b>	449 netto <b>552,27 brutto</b>	489 netto <b>601,47 brutto</b>	P

oferta: P – premium, S – standard, EX – express

TERMIN REALIZACJI podano w dniach kalendarzowych.

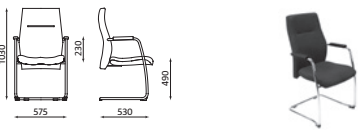
ZP – ZA POTWIERDZENIEM – oznacza każdorazowe uzgadnianie terminu realizacji z Działem Handlowym.

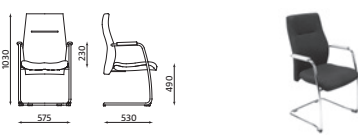

ważne informacje	objętość kartonu [m <sup>3</sup> ]	ilość w kartonie [szt.]	waga netto 1 szt. [kg]	siedzisko		MODEL wymiary podane w mm	 <b>2</b> lata na produkt <b>GWARANCJA</b> <b>lata</b> <b>4</b> <small>na podnośnik pneumatyczny</small>
				szer. [mm]	głęb. [mm]		
 <b>REMDEX</b>	0,185	1	14,50	500	450		OFFICER NET gts ts16 z mechanizmem Epron Synchron
 <b>REMDEX</b>	0,185	1	15,50	500	450		OFFICER NET R19I ts16 z mechanizmem Epron Synchron
 <b>REMDEX</b>	0,185	1	15,50	500	450÷510		OFFICER NET R19I ts16 z mechanizmem Epron Synchron i regulacją głębokości siedziska
 <b>REMDEX</b> 	0,18	1	18,10	500	440		ORLANDO R16H steel28 chrome z mechanizmem Epron Synchron
 <b>REMDEX</b> 	0,18	1	18,10	500	420÷480		ORLANDO UP R16H steel28 chrome z mechanizmem Epron Synchron i regulacją głębokości siedziska
<b>REMDEX</b> 	0,21	1	18,60	500	450		ORLANDO HB R16H steel28 chrome z mechanizmem Epron Synchron
	0,21	1	19,80	500	440÷500		ORLANDO HB R16H steel28 chrome z mechanizmem Epron Synchron i regulacją głębokości siedziska
<b>REMDEX</b> 	0,45	1	12,70	500	460		ORLANDO lux steel cfp chrome
<b>REMDEX</b> 	0,45	1	12,70	500	460		ORLANDO wood steel cfp chrome
<b>REMDEX</b>	0,10	1	11,90	440	395÷420		PERFECT gtp profil z mechanizmem CPT



SZCZEGÓLNE WYKONCZENIE	TERMIN REALIZACJI	CENA MODELU W ZALEŻNOŚCI OD WYKOŃCZENIA [zł]							OFERTA
		SKÓRA DWOINA (SP)	SKÓRA LICOWA (SD/LE)	TAPICERKA PODSTAWOWA (C) MICRO (M) SKAJ (V)	OBAN (EF) LUCIA (YB)	NOBLE LUX (NL) MICROFIBRA (CM) SOTI (SI)	CONTRACT (YN) NEXUS (UNY)	OXYGEN (OX)	
		front tapicerowany skórą	front tapicerowany skórą						
	14				664 netto <b>816,72 brutto</b>	tylko w CM 670 netto <b>824,10 brutto</b>	679 netto <b>835,17 brutto</b>	688 netto <b>846,24 brutto</b>	P
	14				779 netto <b>958,17 brutto</b>	tylko w CM 785 netto <b>965,55 brutto</b>	794 netto <b>976,62 brutto</b>	803 netto <b>987,69 brutto</b>	P
	14				834 netto <b>1025,82 brutto</b>	tylko w CM 840 netto <b>1033,20 brutto</b>	849 netto <b>1044,27 brutto</b>	858 netto <b>1055,34 brutto</b>	P
	14		1111 netto <b>1366,53 brutto</b>	tylko w M 861 netto <b>1059,03 brutto</b>	tylko w EF 890 netto <b>1094,70 brutto</b>	tylko w NL, CM 920 netto <b>1131,60 brutto</b>	963 netto <b>1184,49 brutto</b>	1003 netto <b>1233,69 brutto</b>	P
	14		1199 netto <b>1474,77 brutto</b>	tylko w M 962 netto <b>1183,26 brutto</b>	tylko w EF 991 netto <b>1218,93 brutto</b>	tylko w NL, CM 1021 netto <b>1255,83 brutto</b>	1064 netto <b>1308,72 brutto</b>	1104 netto <b>1357,92 brutto</b>	P
	14		1193 netto <b>1467,39 brutto</b>	tylko w M 910 netto <b>1119,30 brutto</b>	tylko w EF 941 netto <b>1157,43 brutto</b>	tylko w NL, CM 975 netto <b>1199,25 brutto</b>	1035 netto <b>1273,05 brutto</b>	1075 netto <b>1322,25 brutto</b>	P
	14		1254 netto <b>1542,42 brutto</b>	tylko w M 971 netto <b>1194,33 brutto</b>	tylko w EF 1002 netto <b>1232,46 brutto</b>	tylko w NL, CM 1036 netto <b>1274,28 brutto</b>	1096 netto <b>1348,08 brutto</b>	1136 netto <b>1397,28 brutto</b>	P
	21		822 netto <b>1011,06 brutto</b>	tylko w M 600 netto <b>738,00 brutto</b>	tylko w EF 633 netto <b>778,59 brutto</b>	tylko w NL, CM 664 netto <b>816,72 brutto</b>	707 netto <b>869,61 brutto</b>	747 netto <b>918,81 brutto</b>	P
DREWNO	21		822 netto <b>1011,06 brutto</b>	tylko w M 600 netto <b>738,00 brutto</b>	tylko w EF 633 netto <b>778,59 brutto</b>	tylko w NL, CM 664 netto <b>816,72 brutto</b>	707 netto <b>869,61 brutto</b>	747 netto <b>918,81 brutto</b>	P
	7	tylko w CU-24, C-29, CU-14 189 netto <b>232,47 brutto</b>							EX
	5	tylko w C-38, C-11 189 netto <b>232,47 brutto</b>							













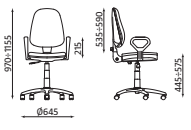







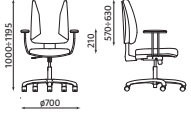

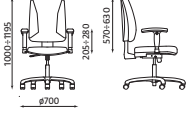

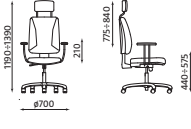
drewno: 1.007, 1.040, 1.010, 1.008, 1.016, 1.042, 1.023, 1.031, 1.033, 1.043

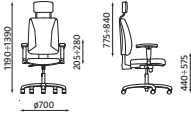
oferta: P – premium, S – standard, EX – express

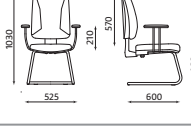
TERMIN REALIZACJI podano w dniach kalendarzowych.

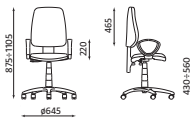
ZP – ZA POTWIERDZENIEM – oznacza każdorazowe uzgadnianie terminu realizacji z Działem Handlowym.

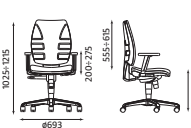

ważne informacje	objętość kartonu [m <sup>3</sup> ]	ilość w kartonie [szt.]	waga netto 1 szt. [kg]	siedzisko		MODEL wymiary podane w mm	
				szer. [mm]	głęb. [mm]		
	0,10	1	12,44	460	440÷470	 	PRESTIGE profil gtp13 ts02 z mechanizmem CPT
	0,10	1	12,44	460	440÷470	 	PRESTIGE profil R3D ts02 z mechanizmem CPT
	0,10	1	11,70	460	440÷470	 	PRESTIGE profil R3W ts02 z mechanizmem CPT
	0,18	1	15,30	510	435	 	QUATRO gtp25i steel04 chrome z mechanizmem Active-1
	0,18	1	15,30	510	435	 	QUATRO R2C steel04 chrome z mechanizmem Active-1
	0,21	1	16,00	510	435	 	QUATRO HR gtp25i steel04 chrome z mechanizmem Active-1
	0,21	1	16,00	510	435	 	QUATRO HR R2C steel04 chrome z mechanizmem Active-1
	0,23	1	13,20	510	415÷460	 	QUATRO cfp 25i chrome
	0,15	1	11,10	440	440	 	REFLEX gtp2 ts02 z mechanizmem Ergon 2L
	0,185	1	14,80	470	430	 	ROXY PW R19I steel36 chrome z mechanizmem lmarc 660



SZCZEGÓLNE WYKOŃCZENIE	TERMIN REALIZACJI	CENA MODELU W ZALEŻNOŚCI OD WYKOŃCZENIA [zł]							OFERTA
		SKÓRA DWOINA (SP)	SKÓRA LICOWA (SD/LE)	TAPICERKA PODSTAWOWA (C) MICRO (M) SKAJ (V)	OBAN (EF) LUCIA (YB)	NOBLE LUX (NL) MICROFIBRA (CM) SOTI (SI)	CONTRACT (YN) NEXUS (UNY)	OXYGEN (OX)	
		front tapicerowany skórą	front tapicerowany skórą						
	14			również w CU 234 netto <b>287,82 brutto</b>	tylko w EF 251 netto <b>308,73 brutto</b>				S
	14			również w CU 267 netto <b>328,41 brutto</b>	tylko w EF 286 netto <b>351,78 brutto</b>				S
1.007, 1.008, 1.010, 1.031	14			również w CU 286 netto <b>351,78 brutto</b>	tylko w EF 303 netto <b>372,69 brutto</b>				S
	14			również w CU 186 netto <b>228,78 brutto</b>	tylko w EF 205 netto <b>252,15 brutto</b>				S
	14			tylko w M 651 netto <b>800,73 brutto</b>	655 netto <b>805,65 brutto</b>		704 netto <b>865,92 brutto</b>	735 netto <b>904,05 brutto</b>	P
	14			tylko w M 708 netto <b>870,84 brutto</b>	710 netto <b>873,30 brutto</b>		761 netto <b>936,03 brutto</b>	792 netto <b>974,16 brutto</b>	P
	14			tylko w M 714 netto <b>878,22 brutto</b>	718 netto <b>883,14 brutto</b>		772 netto <b>949,56 brutto</b>	804 netto <b>988,92 brutto</b>	P
	14			tylko w M 770 netto <b>947,10 brutto</b>	773 netto <b>950,79 brutto</b>		828 netto <b>1018,44 brutto</b>	859 netto <b>1056,57 brutto</b>	P
	14			tylko w M 488 netto <b>600,24 brutto</b>	490 netto <b>602,70 brutto</b>		537 netto <b>660,51 brutto</b>	569 netto <b>699,87 brutto</b>	P
	7	tylko w CU-14, C-38, C-11 296 netto <b>364,08 brutto</b>							EX
	5	tylko w C-29 296 netto <b>364,08 brutto</b>							
	14				797 netto <b>980,31 brutto</b>		833 netto <b>1024,59 brutto</b>	854 netto <b>1050,42 brutto</b>	P

oferta: P – premium, S – standard, EX – express

ważne informacje	objętość kartonu [m <sup>3</sup> ]	ilość w kartonie [szt.]	waga netto 1 szt. [kg]	siedzisko		MODEL		
				szer. [mm]	głęb. [mm]	wymiary podane w mm		
REMODEX	0,10	1	11,50	460	425÷465			SMART gtp27 ts02 z mechanizmem CPT
REMODEX	0,10	1	11,50	460	425÷465			SMART R ts02 z mechanizmem CPT
REMODEX	0,12	1	12,50	460	425÷465			SMART R steel01 chrome z mechanizmem CPT
REMODEX	0,10	1	10,50	460	425÷465			SMART gts ts02 z mechanizmem CPT
REMODEX	0,10	1	11,50	460	425÷465			SMART white gtp27 ts02 z mechanizmem CPT
REMODEX	0,10	1	10,50	460	425÷465			SMART white gts ts02 z mechanizmem CPT
REMODEX	0,102	1	12,44	460	430			STILLO 09 gtp18 z mechanizmem Active-1
REMODEX	0,102	1	12,44	460	430			STILLO 10 gtp18 z mechanizmem Active-1
 REMODEX	0,185	1	12,30	480	390			TAKTIK gtp42 ts16 z mechanizmem Ergon 2L

2 lata  
na produkt  
GWARANCJA  
lata  
4  
na podzespoły  
pneumatyczne





















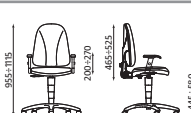

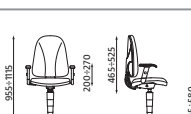
Produkty posiadają Atest Badań Wytrzymałościowych.

Nowy Styl zastrzega sobie prawo do zmian: konstrukcyjnych, wymiarów, terminów dostaw; usunięcia produktów i zmian w paletce wykończeń.

SZCZEGÓŁOWE WYKOŃCZENIE	TERMIN REALIZACJI	CENA MODELU W ZALEŻNOŚCI OD WYKOŃCZENIA [zł]							OFERTA
		SKÓRA DWOINA (SP)	SKÓRA LICOWA (SD/LE)	TAPICERKA PODSTAWOWA (C) MICRO (M) SKAJ (V)	OBAN (EF) LUCIA (YB)	NOBLE LUX (NL) MICROFIBRA (CM) SOTI (SI)	CONTRACT (YN) NEXUS (UNY)	OXYGEN (OX)	
		front tapicerowany skórą	front tapicerowany skórą						
	14			również w CU 217 netto <b>266,91 brutto</b>	tylko w EF 231 netto <b>284,13 brutto</b>				S
	14			również w CU 262 netto <b>322,26 brutto</b>	tylko w EF 277 netto <b>340,71 brutto</b>				S
	14			również w CU 321 netto <b>394,83 brutto</b>	tylko w EF 335 netto <b>412,05 brutto</b>				S
	14			również w CU 178 netto <b>218,94 brutto</b>	tylko w EF 193 netto <b>237,39 brutto</b>				S
	14			również w CU 240 netto <b>295,20 brutto</b>	tylko w EF 256 netto <b>314,88 brutto</b>				S
	14			również w CU 198 netto <b>243,54 brutto</b>	tylko w EF 214 netto <b>263,22 brutto</b>				S
	21			tylko w C, M 333 netto <b>409,59 brutto</b>	350 netto <b>430,50 brutto</b>	tylko w NL, CM 373 netto <b>458,79 brutto</b>	395 netto <b>485,85 brutto</b>		P
	21			tylko w C, M 349 netto <b>429,27 brutto</b>	368 netto <b>452,64 brutto</b>	tylko w NL, CM 390 netto <b>479,70 brutto</b>	412 netto <b>506,76 brutto</b>		P
	7	tylko w EF-809, EF-031, YB-130, YB-026, YB-009 368 netto <b>452,64 brutto</b>							EX
	5	tylko w YB-105 368 netto <b>452,64 brutto</b>							
	14			tylko w C, CU, M 376 netto <b>462,48 brutto</b>	tylko w EF 391 netto <b>480,93 brutto</b>				S

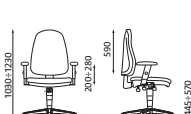
oferta: P – premium, S – standard, EX – express











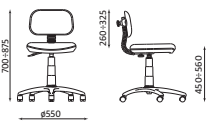

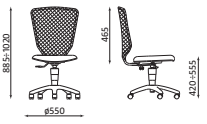

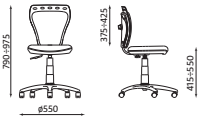

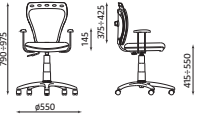

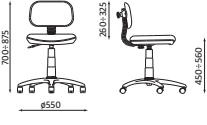
ważne informacje	objętość kartonu [m <sup>3</sup> ]	ilość w kartonie [szt.]	waga netto 1 szt. [kg]	siedzisko		MODEL wymiary podane w mm	 <b>2</b> lata na produkt <b>GWARANCJA</b> <b>lata</b> <small>na podzespoły mechaniczne</small> <b>4</b>
				szer. [mm]	głęb. [mm]		
 <b>REMODEX</b>	0,185	1	12,30	480	390	 	TAKTIK R19T ts16 z mechanizmem Ergon 2L
 <b>REMODEX</b>	0,10	1	12,10	440	395÷420	 	TEMA gtp6 profil ts02 z mechanizmem CPT
<b>REMODEX</b>	0,10	1	10,80	470	425 ÷ 465	 	WEBST@R gtp2 z mechanizmem CPT
<b>REMODEX</b>	0,12	1	12,60	470	415 ÷ 450	 	WEBST@R gtp2 z mechanizmem Kontakt
<b>REMODEX</b>	0,10	1	12,00	470	425 ÷ 465	 	WEBST@R R1E z mechanizmem CPT
<b>REMODEX</b>	0,12	1	13,00	470	415 ÷ 450	 	WEBST@R R1E z mechanizmem Kontakt
 <b>REMODEX</b> <small>DLUŻSZA GWARANCJA</small>	0,185	1	15,90	540	480	 	XL PRO gtp47 ts16 z mechanizmem IBRA
 <b>REMODEX</b> <small>DLUŻSZA GWARANCJA</small>	0,185	1	15,90	540	480	 	XL PRO R15G-3 steel36 chrome z mechanizmem IBRA

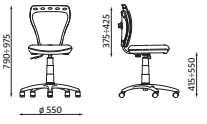

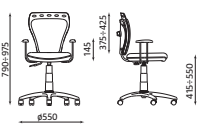

SZCZEGÓLNE WYKOŃCZENIE	TERMIN REALIZACJI	CENA MODELU W ZALEŻNOŚCI OD WYKOŃCZENIA [zł]							OFERTA
		SKÓRA DWOINA (SP)	SKÓRA LICOWA (SD/LE)	TAPICERKA PODSTAWOWA (C) MICRO (M) SKAJ (V)	OBAN (EF) LUCIA (YB)	NOBLE LUX (NL) MICROFIBRA (CM) SOTI (SI)	CONTRACT (YN) NEXUS (UNY)	OXYGEN (OX)	
		front tapicerowany skórą	front tapicerowany skórą						
	14			tylko w C, CU, M 417 netto <b>512,91 brutto</b>	tylko w EF 432 netto <b>531,36 brutto</b>				S
	14			również w CU 195 netto <b>239,85 brutto</b>	tylko w EF 213 netto <b>261,99 brutto</b>				S
	14			268 netto <b>329,64 brutto</b>	287 netto <b>353,01 brutto</b>				P
	14			306 netto <b>376,38 brutto</b>	325 netto <b>399,75 brutto</b>				P
	14			321 netto <b>394,83 brutto</b>	341 netto <b>419,43 brutto</b>				P
	14			361 netto <b>444,03 brutto</b>	381 netto <b>468,63 brutto</b>				P
	7	tylko w CU-24, C-29, CU-14, C-38, C-11 361 netto <b>444,03 brutto</b>							EX
	14			tylko w C, CU, M 524 netto <b>644,52 brutto</b>	tylko w EF 546 netto <b>671,58 brutto</b>				S
	14			tylko w C, CU, M 774 netto <b>952,02 brutto</b>	tylko w EF 797 netto <b>980,31 brutto</b>				S
	7	tylko w YB-130, YB-105, YB-009 797 netto <b>980,31 brutto</b>							EX
	5	tylko w YB-026 797 netto <b>980,31 brutto</b>							

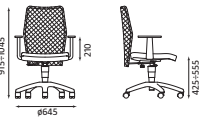









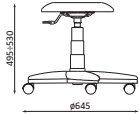

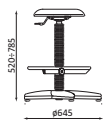

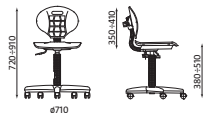

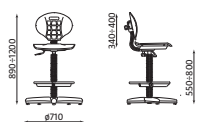

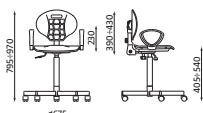
oferta: P – premium, S – standard, EX – express

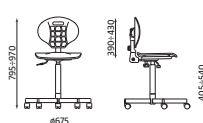
ważne informacje	objętość kartonu [m <sup>3</sup> ]	ilość w kartonie [szt.]	waga netto 1 szt. [kg]	siedzisko		MODEL wymiary podane w mm	 <b>2</b> lata na produkt <b>GWARANCJA</b> <b>lata</b> na podzespoły <b>4</b> pneumatycy
				szer. [mm]	głęb. [mm]		
	0,06	1	5,50	400	360÷390	 	BAMBINO gts ts22
	0,09	1	8,70	430	380÷400	 	BOBI gts ts22
	0,06	1	5,50	405	340÷370	 	CARTOONS LINE gts ts22
	0,06	1	6,50	405	340÷370	 	CARTOONS LINE gtp ts22
	0,06	1	5,50	400	360÷390	 	CARTOONS LINE SMALL ts22
<b>REMODEX</b>	0,09	1	5,75	405	340÷370	 	MINISTYLE gts ts22 black
							MINISTYLE gts ts22 alu
	0,09	1	6,85	405	340÷370	 	MINISTYLE gtp ts22 black
							MINISTYLE gtp ts22 alu
	0,10	1	8,70	440	400÷440	 	PICCOLO gtp44 ts02

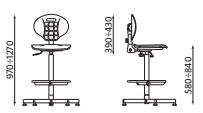

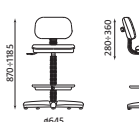
TERMIN REALIZACJI	CENA MODELU W ZALEŻNOŚCI OD WYKOŃCZENIA [zł]				OFERTA
	TAPICERKA PODSTAWOWA (CU/C)	MICRO (M)	OBAN (EF)	TAPICERKA DZIECIĘCA (KID)	
14	132 netto 162,36 brutto	132 netto 162,36 brutto		132 netto 162,36 brutto	S
14	216 netto 265,68 brutto	216 netto 265,68 brutto	również w YB 226 netto 277,98 brutto		S
14	Dostępne wykończenia: Princess, Superstar, Turbo, Butterfly, Dino, La Liga, Pirate, Pony 160 netto 196,80 brutto				S
14	Dostępne wykończenia: Princess, Superstar, Turbo, Butterfly, Dino, La Liga, Pirate, Pony 193 netto 237,39 brutto				S
14	Dostępne wykończenia: Princess, Superstar, Turbo, Butterfly, Dino, La Liga, Pirate, Pony 143 netto 175,89 brutto				S
14	141 netto 173,43 brutto	141 netto 173,43 brutto	151 netto 185,73 brutto	141 netto 173,43 brutto	S
14	141 netto 173,43 brutto	141 netto 173,43 brutto	151 netto 185,73 brutto	141 netto 173,43 brutto	S
14	168 netto 206,64 brutto	168 netto 206,64 brutto	178 netto 218,94 brutto	168 netto 206,64 brutto	S
14	168 netto 206,64 brutto	168 netto 206,64 brutto	178 netto 218,94 brutto	168 netto 206,64 brutto	S
14	338 netto 415,74 brutto	338 netto 415,74 brutto	również w YB 350 netto 430,50 brutto		S

oferta: P – premium, S – standard, EX – express

ważne informacje	objętość kartonu [m <sup>3</sup> ]	ilość w kartonie [szt.]	waga netto 1 szt. [kg]	wymiary siedziska		MODEL wymiary podane w mm	 <b>GWARANCJA</b> lata <b>4</b> <small>na podłożach pneumatycznych</small>
				szer. [mm]	głęb. [mm]		
REMODEX	0,07	1	6,50	Ø360		 	GOLIAT ts12
REMODEX	0,07	1	8,50	Ø360		 	GOLIAT ts12 Ring Base
REMODEX	0,08	1	10,00	460	440÷470	 	NEGRO gts ts13
REMODEX	0,10	1	11,90	460	440÷470	 	NEGRO gts ts13 Ring Base
	0,07	1	10,50	460	440÷470	 	NEGRO II gtp steel26 z mechanizmem CPT
REMODEX	0,07	1	10,50	460	440÷470	 	NEGRO II gts steel26 z mechanizmem CPT
	0,10	1	11,90	460	440÷470	 	NEGRO II gts steel26 Ring Base z mechanizmem CPT
REMODEX	0,10	1	10,34	440	395÷420	 	SENIOR gts ts12 Ring Base
REMODEX	0,10	1	11,50	460	425÷465	 	SMART gts ts02 Ring Base











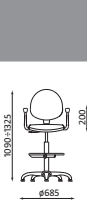

Produkty posiadają Atest Badań Wytrzymałościowych.

Nowy Styl zastrzega sobie prawo do zmian: konstrukcyjnych, wymiarów, terminów dostaw; usunięcia produktów i zmian w paletce wykończeń.

## KRZESŁA DO ZASTOSOWAŃ SPECJALISTYCZNYCH

SZCZEGÓLWE WYKOŃCZENIE	TERMIN REALIZACJI	CENA MODELU W ZALEŻNOŚCI OD WYKOŃCZENIA [zł]				OFERTA
		TWORZYWO SZTUCZNE	TAPICERKA PODSTAWOWA (C/U/C)	MICRO (M)	SKAJ (V)	
	14		132 netto <b>162,36 brutto</b>		132 netto <b>162,36 brutto</b>	S
	14		212 netto <b>260,76 brutto</b>		212 netto <b>260,76 brutto</b>	S
tylko w kolorze czarnym	14	340 netto <b>418,20 brutto</b>				S
tylko w kolorze czarnym	14	406 netto <b>499,38 brutto</b>				S
tylko w kolorze czarnym	14	388 netto <b>477,24 brutto</b>				S
tylko w kolorze czarnym	14	355 netto <b>436,65 brutto</b>				S
tylko w kolorze czarnym	14	423 netto <b>520,29 brutto</b>				S
	14		248 netto <b>305,04 brutto</b>		248 netto <b>305,04 brutto</b>	S
	14		252 netto <b>309,96 brutto</b>	252 netto <b>309,96 brutto</b>	252 netto <b>309,96 brutto</b>	S

oferta: P – premium, S – standard, EX – express

ważne informacje	objętość kartonu [m <sup>3</sup> ]	ilość w kartonie [szt.]	waga netto 1 szt. [kg]	wymiary siedziska				<b>MODEL</b> wymiary podane w mm	
				szer. [mm]	głęb. [mm]				
<b>REMODEX</b>	0,15	1	13,50	460	440÷470			SMART gtp27 steel02 Ring Base z mechanizmem CPT	
<b>REMODEX</b>	0,09	1	8,10	405	405			WEREK steel26	
<b>REMODEX</b>	0,09	1	10,00	405	405			WEREK steel26 Foot Base	
<b>REMODEX</b>	0,09	1	7,35	350	345			WORKER ts02 Ring Base	



## KRZESŁA DO ZASTOSOWAŃ SPECJALISTYCZNYCH







SZCZEGÓŁOWE WYKOŃCZENIE	TERMIN REALIZACJI	CENA MODELU W ZALEŻNOŚCI OD WYKOŃCZENIA [zł]				OFERTA
		TWORZYWO SZTUCZNE	TAPICERKA PODSTAWOWA (CU/C)	MICRO (M)	SKAJ (V)	
	14		361 netto 444,03 brutto	361 netto 444,03 brutto	361 netto 444,03 brutto	S
1.007	21	225 netto 276,75 brutto				S
1.007	21	298 netto 366,54 brutto				S
tylko w kolorze czarnym	14	324 netto 398,52 brutto				S

oferta: P – premium, S – standard, EX – express

TERMIN REALIZACJI podano w dniach kalendarzowych.

ZP – ZA POTWIERDZENIEM – oznacza każdorazowe uzgadnianie terminu realizacji z Działem Handlowym.

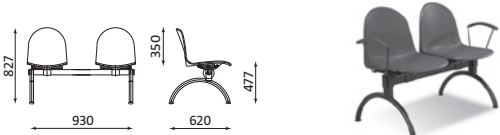
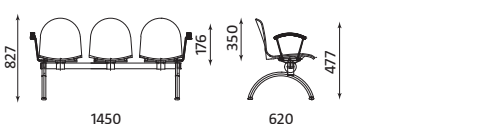
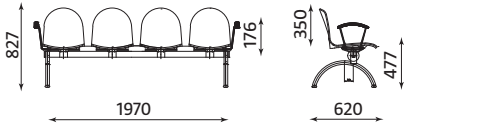
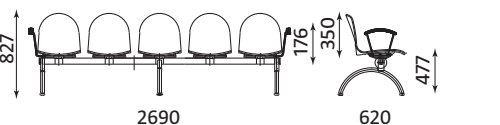

ważne informacje	składowanie w stosie [max. ilość szt.]	objętość kartonu [m <sup>3</sup> ]	ilość w kartonie [szt.]	waga netto 1 szt. [kg]	siedzisko		MODEL wymiary podane w mm	
					szer. [mm]	głęb. [mm]		
<b>REMODEX</b>	8	0,34	4	4,32	460	460		AMIGO alu
								AMIGO chrome
<b>REMODEX</b>	8	0,34	4	4,80	460	460		AMIGO click alu
								AMIGO click chrome
								AMIGO click sposób łączenia
<b>REMODEX</b>	8	0,34	4	5,74	460	460		AMIGO ARM alu
								AMIGO ARM chrome
<b>REMODEX</b>		0,16	1	23,00	460	460		AMIGO ARM-2 black
								AMIGO ARM-2 alu
<b>REMODEX</b>		0,16	1	27,00	460	460		AMIGO ARM-3 black
								AMIGO ARM-3 alu
<b>REMODEX</b>		0,16	1	35,00	460	460		AMIGO ARM-4 black
								AMIGO ARM-4 alu
<b>REMODEX</b>		0,18	1	43,00	460	460		AMIGO ARM-5 black
								AMIGO ARM-5 alu
								AMIGO connector do połączenia rurek (2 sztuki w komplecie)









SZCZEGÓŁOWE WYKOŃCZENIE	TERMIN REALIZACJI	CENA MODELU W ZALEŻNOŚCI OD WYKOŃCZENIA [zł]					
		TAPICERKA PODSTAWOWA (C) MICRO (M) SKAJ (V)	OBAN (EF) LUCIA (YB)	NOBLE LUX (NL) MICROFIBRA (CM) SOTI (SI)	CONTRACT (YN) NEXUS (UNY)	OXYGEN (OX)	OFERTA
K02, K05, K32, K36, K53, K30, K31, K33, K35, K59, K51, K01	21	94 netto <b>115,62 brutto</b>					P
K02, K05, K32, K36, K53, K30, K31, K33, K35, K59, K51, K01	14	96 netto <b>118,08 brutto</b>					P
K02, K05, K32, K36, K53, K30, K31, K33, K35, K59, K51, K01	21	131 netto <b>161,13 brutto</b>					P
K02, K05, K32, K36, K53, K30, K31, K33, K35, K59, K51, K01	14	135 netto <b>166,05 brutto</b>					P
K02, K05, K32, K36, K53, K30, K31, K33, K35, K59, K51, K01	21	137 netto <b>168,51 brutto</b>					P
K02, K05, K32, K36, K53, K30, K31, K33, K35, K59, K51, K01	14	140 netto <b>172,20 brutto</b>					P
K02, K05, K32, K36, K53, K30, K31, K33, K35, K59, K51, K01	21	393 netto <b>483,39 brutto</b>					P
K02, K05, K32, K36, K53, K30, K31, K33, K35, K59, K51, K01	21	412 netto <b>506,76 brutto</b>					P
K02, K05, K32, K36, K53, K30, K31, K33, K35, K59, K51, K01	21	489 netto <b>601,47 brutto</b>					P
K02, K05, K32, K36, K53, K30, K31, K33, K35, K59, K51, K01	21	512 netto <b>629,76 brutto</b>					P
K02, K05, K32, K36, K53, K30, K31, K33, K35, K59, K51, K01	21	590 netto <b>725,70 brutto</b>					P
K02, K05, K32, K36, K53, K30, K31, K33, K35, K59, K51, K01	21	616 netto <b>757,68 brutto</b>					P
K02, K05, K32, K36, K53, K30, K31, K33, K35, K59, K51, K01	21	745 netto <b>916,35 brutto</b>					P
K02, K05, K32, K36, K53, K30, K31, K33, K35, K59, K51, K01	21	779 netto <b>958,17 brutto</b>					P
	ZP	9 netto <b>11,07 brutto</b>					P

oferta: P – premium, S – standard, EX – express

TERMIN REALIZACJI podano w dniach kalendarzowych.

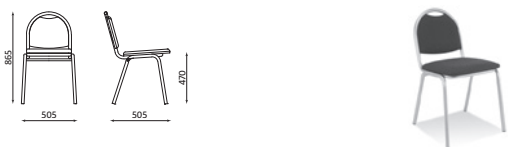
ZP – ZA POTWIERDZENIEM – oznacza każdorazowe uzgadnianie terminu realizacji z Działem Handlowym.



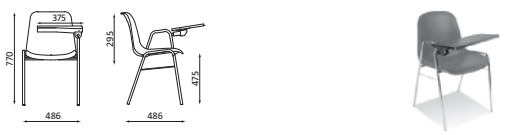
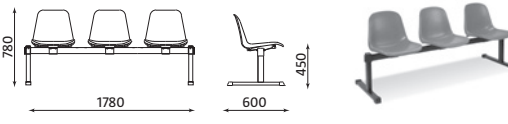
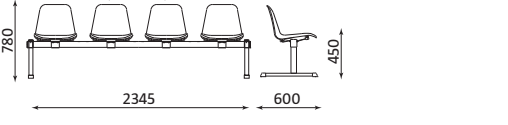
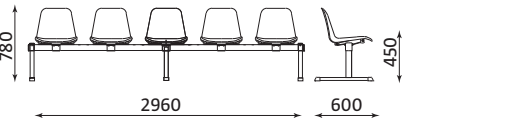









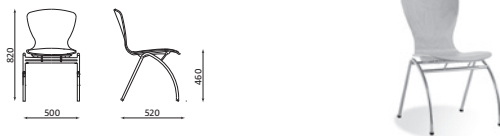

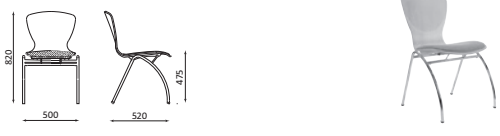

ważne informacje	składowanie w stosie [max. ilość szt.]	objętość kartonu [m <sup>3</sup> ]	ilość w kartonie [szt.]	waga netto 1 szt. [kg]	siedzisko		MODEL wymiary podane w mm	
					szer. [mm]	głęb. [mm]		
<b>REMODEX</b>	6	0,34	4	7,10	400	450		ARIOSO alu
								ARIOSO black
<b>REMODEX</b>	8	0,25	6	4,40	400	430		ASCONA chrome
<b>REMODEX</b>	6	paleta		3,00	440	400		BETA chrome
<b>REMODEX</b>	6	paleta		3,10	440	400		BETA click chrome
<b>REMODEX</b>		0,26	1	4,40	440	400		BETA T chrome (także dla leworęcznych – T/L)
<b>REMODEX</b>		0,15	1	19,50	440	400		BETA-3 black
<b>REMODEX</b>		0,18	1	24,50	440	400		BETA-4 black
<b>REMODEX</b>		0,21	1	30,70	440	400		BETA-5 black



SZCZEGÓŁOWE WYKOŃCZENIE	TERMIN REALIZACJI	CENA MODELU W ZALEŻNOŚCI OD WYKOŃCZENIA [zł]					
		TAPICERKA PODSTAWOWA (C) MICRO (M) SKAJ (V)	OBAN (EF) LUCIA (YB)	NOBLE LUX (NL) MICROFIBRA (CM) SOTI (SI)	CONTRACT (YN) NEXUS (UNY)	OXYGEN (OX)	OFERTA
	21	również w CU 123 netto <b>151,29 brutto</b>	tylko w EF 145 netto <b>178,35 brutto</b>				S
	7	tylko w C-29, CU-32, CU-14, C-11 123 netto <b>151,29 brutto</b>					EX
	5	tylko w CU-4, CU-24 123 netto <b>151,29 brutto</b>					
	ZP	również w CU 116 netto <b>142,68 brutto</b>	tylko w EF 139 netto <b>170,97 brutto</b>				S
	7	tylko w C-29, CU-32, CU-14, C-11, CU-4, CU-24 116 netto <b>142,68 brutto</b>					EX
TAPICERKA Z TWORZYWA SZTUCZNEGO TYLKO W KOLORZE CZARNYM	14			77 netto <b>94,71 brutto</b>			S
K02, K05, K36, K53, K30, K31, K59, K51	14			72 netto <b>88,56 brutto</b>			S
K36, K31, K59	7			72 netto <b>88,56 brutto</b>			EX
K02, K05, K36, K53, K30, K31, K59, K51	14			79 netto <b>97,17 brutto</b>			S
K02, K05, K36, K53, K30, K31, K59, K51	14			150 netto <b>184,50 brutto</b>			S
K02, K05, K36, K53, K30, K31, K59, K51	21			330 netto <b>405,90 brutto</b>			S
K02, K05, K36, K53, K30, K31, K59, K51	21			407 netto <b>500,61 brutto</b>			S
K02, K05, K36, K53, K30, K31, K59, K51	21			515 netto <b>633,45 brutto</b>			S

oferta: P – premium, S – standard, EX – express

ważne informacje	składowanie w stosie [max. ilość szt.]	objętość kartonu [m <sup>3</sup> ]	ilość w kartonie [szt.]	waga netto 1 szt. [kg]	siedzisko		MODEL wymiary podane w mm	
					szer. [mm]	głęb. [mm]		
	4	0,44	4	6,10	445	455		BINGO wood alu
								BINGO wood chrome
	4	0,44	4	6,50	445	455		BINGO seat plus alu
								BINGO seat plus chrome
	4	0,44	4	6,80	445	455		BINGO plus alu
								BINGO plus chrome
	4	0,5	2	9,00	445	455		BINGO HOCKER wood alu
								BINGO HOCKER wood chrome
								BINGO link do połączenia przednich i tylnych nóg krzeseł BINGO (2 sztuki w komplecie)
	4	0,52	4	7,50	445	455		BINGO ARM wood alu
								BINGO ARM wood chrome
	4	0,52	4	7,80	445	455		BINGO ARM seat plus alu
								BINGO ARM seat plus chrome











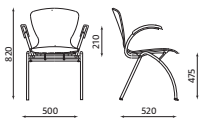

SZCZEGÓLWE WYKOŃCZENIE	TERMIN REALIZACJI	CENA MODELU W ZALEŻNOŚCI OD WYKOŃCZENIA [zł]					OFERTA
		TAPICERKA PODSTAWOWA (C) MICRO (M) SKAJ (V)	OBAN (EF) LUCIA (YB)	NOBLE LUX (NL) MICROFIBRA (CM) SOTI (SI)	CONTRACT (YN) NEXUS (UNY)	OXYGEN (OX)	
DREWNO	21	272 netto 334,56 brutto					P
LAMINAT	21	318 netto 391,14 brutto					
DREWNO	14	277 netto 340,71 brutto					P
LAMINAT	21	322 netto 396,06 brutto					
DREWNO	21	286 netto 351,78 brutto	291 netto 357,93 brutto	294 netto 361,62 brutto	297 netto 365,31 brutto	301 netto 370,23 brutto	P
DREWNO	21	290 netto 356,70 brutto	296 netto 364,08 brutto	299 netto 367,77 brutto	301 netto 370,23 brutto	305 netto 375,15 brutto	P
DREWNO	21	299 netto 367,77 brutto	309 netto 380,07 brutto	315 netto 387,45 brutto	321 netto 394,83 brutto	329 netto 404,67 brutto	P
DREWNO	21	303 netto 372,69 brutto	313 netto 384,99 brutto	320 netto 393,60 brutto	325 netto 399,75 brutto	333 netto 409,59 brutto	P
DREWNO	21	381 netto 468,63 brutto					P
LAMINAT	21	426 netto 523,98 brutto					
DREWNO	14	385 netto 473,55 brutto					P
LAMINAT	21	430 netto 528,90 brutto					
	14	10 netto 12,30 brutto					P
DREWNO	21	366 netto 450,18 brutto					P
DREWNO	14	377 netto 463,71 brutto					P
DREWNO	21	380 netto 467,40 brutto	385 netto 473,55 brutto	388 netto 477,24 brutto	390 netto 479,70 brutto	394 netto 484,62 brutto	P
DREWNO	21	391 netto 480,93 brutto	396 netto 487,08 brutto	399 netto 490,77 brutto	402 netto 494,46 brutto	406 netto 499,38 brutto	P

drewno: 1.007, 1.040, 1.010, 1.008, 1.016, 1.042, 1.023, 1.031, 1.033, 1.043  
 laminat: H1733, H3389, H3005, H3704, W1000, U303, U630, U321, U999, U773, H3005 horizontal

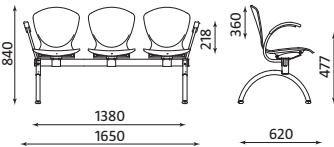
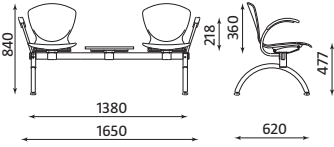
oferta: P – premium, S – standard, EX – express

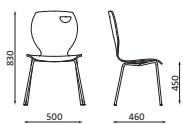
TERMIN REALIZACJI podano w dniach kalendarzowych.  
 ZP – ZA POTWIERDZENIEM – oznacza każdorazowe uzgadnianie terminu realizacji z Działem Handlowym.

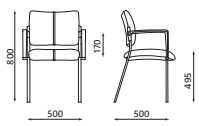

ważne informacje	składowanie w stosie [max. ilość szt.]	objętość kartonu [m <sup>3</sup> ]	ilość w kartonie [szt.]	waga netto 1 szt. [kg]	siedzisko		MODEL wymiary podane w mm	
					szer. [mm]	głęb. [mm]		
	4	0,52	4	7,50	445	455	 	BINGO ARM plus alu
								BINGO ARM plus chrome
REMODEX		0,18	1	28,70	445	450		BINGO-3 ARM wood alu
								BINGO-3 ARM wood black
REMODEX		0,227	1	28,70	445	450		BINGO-3/T ARM wood alu pulpit dostępny w kolorze buk
								BINGO-3/T ARM wood black pulpit dostępny w kolorze buk
								BINGO connector do połączenia ławek (2 sztuki w komplecie)
REMODEX	4	0,32	4	4,50	470	430	 	CAPPUCINO alu
								CAPPUCINO chrome
REMODEX	4	0,4	2	7,20	460	380	 	CINQUE 4L ARM alu
								CINQUE 4L ARM black
								CINQUE 4L ARM chrome



SZCZEGÓLWE WYKOŃCZENIE	TERMIN REALIZACJI	CENA MODELU W ZALEŻNOŚCI OD WYKOŃCZENIA [zł]					
		TAPICERKA PODSTAWOWA (C) MICRO (M) SKAJ (V)	OBAN (EF) LUCIA (YB)	NOBLE LUX (NL) MICROFIBRA (CM) SOTI (SI)	CONTRACT (YN) NEXUS (UNY)	OXYGEN (OX)	OFERTA
DREWNO	21	392 netto <b>482,16 brutto</b>	403 netto <b>495,69 brutto</b>	409 netto <b>503,07 brutto</b>	414 netto <b>509,22 brutto</b>	423 netto <b>520,29 brutto</b>	P
DREWNO	21	404 netto <b>496,92 brutto</b>	414 netto <b>509,22 brutto</b>	420 netto <b>516,60 brutto</b>	426 netto <b>523,98 brutto</b>	434 netto <b>533,82 brutto</b>	P
DREWNO	21	929 netto <b>1142,67 brutto</b>					P
DREWNO	21	929 netto <b>1142,67 brutto</b>					P
DREWNO	21	844 netto <b>1038,12 brutto</b>					P
DREWNO	21	844 netto <b>1038,12 brutto</b>					P
	ZP	10 netto <b>12,30 brutto</b>					P
DREWNO	21	206 netto <b>253,38 brutto</b>					P
LAMINAT	21	249 netto <b>306,27 brutto</b>					
DREWNO	14	209 netto <b>257,07 brutto</b>					P
LAMINAT	21	252 netto <b>309,96 brutto</b>					
1.007, 1.010, 1.033	7	209 netto <b>257,07 brutto</b>					EX
	21	tylko w M 352 netto <b>432,96 brutto</b>	354 netto <b>435,42 brutto</b>		396 netto <b>487,08 brutto</b>	428 netto <b>526,44 brutto</b>	P
	21	tylko w M 352 netto <b>432,96 brutto</b>	354 netto <b>435,42 brutto</b>		396 netto <b>487,08 brutto</b>	428 netto <b>526,44 brutto</b>	P
	21	tylko w M 391 netto <b>480,93 brutto</b>	393 netto <b>483,39 brutto</b>		435 netto <b>535,05 brutto</b>	467 netto <b>574,41 brutto</b>	P

drewno: 1.007, 1.040, 1.010, 1.008, 1.016, 1.042, 1.023, 1.031, 1.033, 1.043

laminat: H1733, H3389, H3005, H3704, W1000, U303, U630, U321, U999, U773, H3005 horizontal

oferta: P – premium, S – standard, EX – express

TERMIN REALIZACJI podano w dniach kalendarzowych.

ZP – ZA POTWIERDZENIEM – oznacza każdorazowe uzgadnianie terminu realizacji z Działem Handlowym.



ważne informacje	składowanie w stosie [max. ilość szt.]	objętość kartonu [m <sup>3</sup> ]	ilość w kartonie [szt.]	waga netto 1 szt. [kg]	siedzisko		MODEL wymiary podane w mm	
					szer. [mm]	głęb. [mm]		
<b>REMODEX</b>	8	0,3	6	4,08	400	430		CORTESSA chrome
 <b>REMODEX</b>	4	0,36	3	6,72	470	475		ELVA
<b>REMODEX</b>	4	0,37	3	6,80	470	475		ELVA click
<b>REMODEX</b>	4	0,32	4	4,90	470	430		ESPRESSO alu
<b>REMODEX</b>	4	0,32	4	5,40	470	430		ESPRESSO seat plus alu
<b>REMODEX</b>	4	0,32	4	5,40	470	430		ESPRESSO seat plus chrome
<b>REMODEX</b>	4	0,32	4	5,40	470	430		ESPRESSO plus alu
<b>REMODEX</b>	4	0,46	3	5,40	530	430		ESPRESSO plus chrome
 <b>REMODEX</b>	4	0,46	3	5,40	530	430		FANO alu
 <b>CATAS</b>	6	0,41	4	3,60	445	420		FANO chrome
 <b>CATAS</b>	6	0,41	4	3,60	445	420		FIUGGI chrome
 <b>REMODEX</b>	6	0,35	4	4,60	445	410		FONDO alu
<b>REMODEX</b>	6	0,35	4	4,60	445	410		FONDO chrome





SZCZEGÓŁOWE WYKOŃCZENIE	TERMIN REALIZACJI	CENA MODELU W ZALEŻNOŚCI OD WYKOŃCZENIA [zł]					OFERTA
		TAPICERKA PODSTAWOWA (C) MICRO (M) SKAJ (V)	OBAN (EF) LUCIA (YB)	NOBLE LUX (NL) MICROFIBRA (CM) SOTI (SI)	CONTRACT (YN) NEXUS (UNY)	OXYGEN (OX)	
K02, K05, K36, K53, K30, K31, K59, K51	14	77 netto 94,71 brutto					S
K31, K30	7	77 netto 94,71 brutto					EX
K02	5	77 netto 94,71 brutto					
DREWNO	14	tylko w C, M 302 netto 371,46 brutto	319 netto 392,37 brutto	361 netto 444,03 brutto	382 netto 469,86 brutto	403 netto 495,69 brutto	P
DREWNO	14	tylko w C, M 331 netto 407,13 brutto	349 netto 429,27 brutto	396 netto 487,08 brutto	412 netto 506,76 brutto	433 netto 532,59 brutto	P
DREWNO	21	206 netto 253,38 brutto					P
LAMINAT	21	249 netto 306,27 brutto					
DREWNO	14	209 netto 257,07 brutto					P
LAMINAT	21	252 netto 309,96 brutto					
DREWNO	21	220 netto 270,60 brutto	225 netto 276,75 brutto	228 netto 280,44 brutto	230 netto 282,90 brutto	235 netto 289,05 brutto	P
DREWNO	21	223 netto 274,29 brutto	228 netto 280,44 brutto	231 netto 284,13 brutto	234 netto 287,82 brutto	238 netto 292,74 brutto	P
DREWNO	21	233 netto 286,59 brutto	243 netto 298,89 brutto	249 netto 306,27 brutto	255 netto 313,65 brutto	263 netto 323,49 brutto	P
DREWNO	21	236 netto 290,28 brutto	246 netto 302,58 brutto	252 netto 309,96 brutto	258 netto 317,34 brutto	266 netto 327,18 brutto	P
TWORZYWO SZTUCZNE	ZP	230 netto 282,90 brutto					P
TWORZYWO SZTUCZNE	ZP	260 netto 319,80 brutto					P
TWORZYWO SZTUCZNE	ZP	189 netto 232,47 brutto					P
TWORZYWO SZTUCZNE	ZP	210 netto 258,30 brutto					P
TWORZYWO SZTUCZNE	ZP	240 netto 295,20 brutto					P

drewno: 1.007, 1.040, 1.010, 1.008, 1.016, 1.042, 1.023, 1.031, 1.033, 1.043

laminat: H1733, H3389, H3005, H3704, W1000, U303, U630, U321, U999, U773, H3005 horizontal











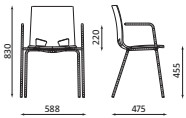

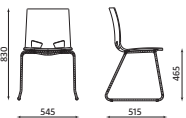

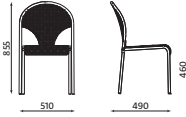

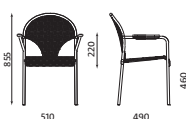
tworzywo sztuczne: szczególne wykończenia we wzorniku katalogu Biuro

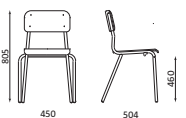
oferta: P – premium, S – standard, EX – express

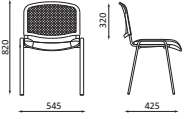
TERMIN REALIZACJI podano w dniach kalendarzowych.

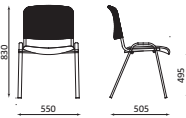
ZP – ZA POTWIERDZENIEM – oznacza każdorazowe uzgadnianie terminu realizacji z Działem Handlowym.

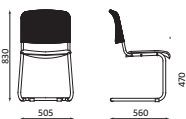

ważne informacje	składowanie w stosie [max. ilość szt.]	objętość kartonu [m <sup>3</sup> ]	ilość w kartonie [szt.]	waga netto 1 szt. [kg]	siedzisko		MODEL wymiary podane w mm		
					szer. [mm]	głęb. [mm]			
 <b>REMODEX</b>	3	0,4	4	5,40	445	410			FONDO ARM alu
									FONDO ARM chrome
 <b>REMODEX</b>	6	0,41	4	5,00	445	410			FONDO cfs alu
									FONDO cfs chrome
 <b>REMODEX</b>	4	0,32	4	4,9	445	415			FRAPPE chrome
<b>REMODEX</b>	6	0,36	2	7,20	410	420			IBIS chrome
<b>REMODEX</b>	6	0,36	2	8,30	410	420			IBIS ARM chrome
<b>REMODEX</b>	4	0,35	4	4,10	370	410			IRYS alu
									IRYS black
 <b>REMODEX</b>	10	0,40	4	6	475	415			ISO ERGO MESH alu
									ISO ERGO MESH black
									ISO ERGO MESH chrome
<b>REMODEX</b>	10	0,40	4	5,80	475	415			ISO NET alu
									ISO NET black
									ISO NET chrome
<b>REMODEX</b>	4	0,40	4	6,60	475	415			ISO NET SWING alu
									ISO NET SWING black
									ISO NET SWING chrome



SZCZEGÓŁOWE WYKOŃCZENIE	TERMIN REALIZACJI	CENA MODELU W ZALEŻNOŚCI OD WYKOŃCZENIA [zł]					
		TAPICERKA PODSTAWOWA (C) MICRO (M) SKAJ (V)	OBAN (EF) LUCIA (YB)	NOBLE LUX (NL) MICROFIBRA (CM) SOTI (SI)	CONTRACT (YN) NEXUS (UNY)	OXYGEN (OX)	OFERTA
TWORZYWO SZTUCZNE	ZP	230 netto <b>282,90 brutto</b>					P
TWORZYWO SZTUCZNE	ZP	270 netto <b>332,10 brutto</b>					P
TWORZYWO SZTUCZNE	ZP	245 netto <b>301,35 brutto</b>					P
TWORZYWO SZTUCZNE	ZP	270 netto <b>332,10 brutto</b>					P
1.007, 1.010, 1.033	7	209 netto <b>257,07 brutto</b>					EX
DREWNO	14	tylko w M 244 netto <b>300,12 brutto</b>	257 netto <b>316,11 brutto</b>	tylko w CM 329 netto <b>404,67 brutto</b>	339 netto <b>416,97 brutto</b>		P
DREWNO	14	tylko w M 301 netto <b>370,23 brutto</b>	314 netto <b>386,22 brutto</b>	tylko w CM 383 netto <b>471,09 brutto</b>	393 netto <b>483,39 brutto</b>		P
1.007	21	118 netto <b>145,14 brutto</b>					S
1.007	ZP	113 netto <b>138,99 brutto</b>					S
	14	139 netto <b>170,97 brutto</b>	144 netto <b>177,12 brutto</b>		162 netto <b>199,26 brutto</b>	165 netto <b>202,95 brutto</b>	P
	14	136 netto <b>167,28 brutto</b>	141 netto <b>173,43 brutto</b>		159 netto <b>195,57 brutto</b>	162 netto <b>199,26 brutto</b>	P
	14	151 netto <b>185,73 brutto</b>	156 netto <b>191,88 brutto</b>		173 netto <b>212,79 brutto</b>	186 netto <b>228,78 brutto</b>	P
	14	165 netto <b>202,95 brutto</b>	167 netto <b>205,41 brutto</b>	175 netto <b>215,25 brutto</b>	183 netto <b>225,09 brutto</b>		P
	14	159 netto <b>195,57 brutto</b>	162 netto <b>199,26 brutto</b>	170 netto <b>209,10 brutto</b>	178 netto <b>218,94 brutto</b>		P
	14	175 netto <b>215,25 brutto</b>	178 netto <b>218,94 brutto</b>	185 netto <b>227,55 brutto</b>	193 netto <b>237,39 brutto</b>		P
	14	183 netto <b>225,09 brutto</b>	185 netto <b>227,55 brutto</b>	193 netto <b>237,39 brutto</b>	201 netto <b>247,23 brutto</b>		P
	14	178 netto <b>218,94 brutto</b>	180 netto <b>221,40 brutto</b>	187 netto <b>230,01 brutto</b>	196 netto <b>241,08 brutto</b>		P
	14	203 netto <b>249,69 brutto</b>	205 netto <b>252,15 brutto</b>	213 netto <b>261,99 brutto</b>	221 netto <b>271,83 brutto</b>		P











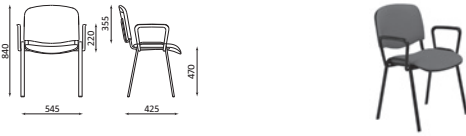

drewno: 1.007, 1.040, 1.010, 1.008, 1.016, 1.042, 1.023, 1.031, 1.033, 1.043  
tworzywo sztuczne: szczególwe wykończenia we wzorniku katalogu Biuro

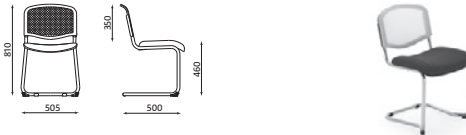
oferta: P – premium, S – standard, EX – express

TERMIN REALIZACJI podano w dniach kalendarzowych.

ZP – ZA POTWIERDZENIEM – oznacza każdorazowe uzgadnianie terminu realizacji z Działem Handlowym.

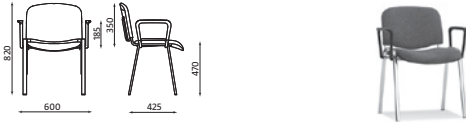

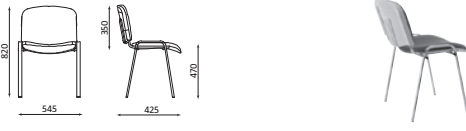









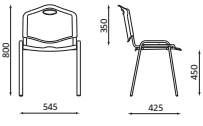

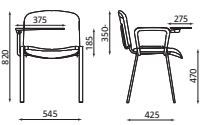
ważne informacje	składowanie w stosie [max. ilość szt.]	objętość kartonu [m³]	ilość w kartonie [szt.]	waga netto 1 szt. [kg]	siedzisko		MODEL wymiary podane w mm	
					szer. [mm]	głęb. [mm]		
<b>REMODEX</b>	10	paleta: 50		6,65	475	415		ISO LUX alu
								ISO LUX black
								ISO LUX chrome
<b>REMODEX</b>	10	paleta: 50		8,65	475	415		ISO LUX ARM alu
								ISO LUX ARM black
								ISO LUX ARM chrome
	4	0,35	4	6,30	470	468		ISO SWING ERGO MESH alu
								ISO SWING ERGO MESH black
								ISO SWING ERGO MESH chrome
 <b>REMODEX</b> 	10	paleta: 50		6,65	475	415		ISO alu
								ISO black
								ISO chrome
 <b>REMODEX</b> 	10	paleta: 50		8,65	475	415		ISO ARM alu
								ISO ARM black
								ISO ARM chrome
<b>REMODEX</b> 	10	paleta: 50		6,65	475	415		ISO BIANCO chrome

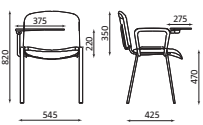

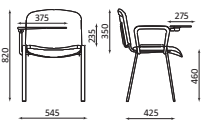
SZCZEGÓŁOWE WYKOŃCZENIE	TERMIN REALIZACJI	CENA MODELU W ZALEŻNOŚCI OD WYKOŃCZENIA [zł]						
		TAPICERKA PODSTAWOWA (C) MICRO (M) SKAJ (V)	OBAN (EF) LUCIA (YB)	NOBLE LUX (NL) MICROFIBRA (CM) SOTI (SI)	CONTRACT (YN) NEXUS (UNY)	OXYGEN (OX)	OFERTA	
	14	109 netto <b>134,07 brutto</b>	119 netto <b>146,37 brutto</b>	128 netto <b>157,44 brutto</b>	135 netto <b>166,05 brutto</b>		P	
	14	102 netto <b>125,46 brutto</b>	112 netto <b>137,76 brutto</b>	121 netto <b>148,83 brutto</b>	128 netto <b>157,44 brutto</b>		P	
	14	120 netto <b>147,60 brutto</b>	129 netto <b>158,67 brutto</b>	139 netto <b>170,97 brutto</b>	145 netto <b>178,35 brutto</b>		P	
	14	154 netto <b>189,42 brutto</b>	164 netto <b>201,72 brutto</b>	173 netto <b>212,79 brutto</b>	180 netto <b>221,40 brutto</b>		P	
	14	147 netto <b>180,81 brutto</b>	157 netto <b>193,11 brutto</b>	166 netto <b>204,18 brutto</b>	173 netto <b>212,79 brutto</b>		P	
	14	164 netto <b>201,72 brutto</b>	174 netto <b>214,02 brutto</b>	183 netto <b>225,09 brutto</b>	190 netto <b>233,70 brutto</b>		P	
	14	194 netto <b>238,62 brutto</b>	199 netto <b>244,77 brutto</b>		217 netto <b>266,91 brutto</b>	220 netto <b>270,60 brutto</b>	P	
	14	191 netto <b>234,93 brutto</b>	196 netto <b>241,08 brutto</b>		214 netto <b>263,22 brutto</b>	217 netto <b>266,91 brutto</b>	P	
	14	212 netto <b>260,76 brutto</b>	217 netto <b>266,91 brutto</b>		235 netto <b>289,05 brutto</b>	239 netto <b>293,97 brutto</b>	P	
	14	również w CU 93 netto <b>114,39 brutto</b>	tylko w EF 104 netto <b>127,92 brutto</b>				S	
	14	również w CU 87 netto <b>107,01 brutto</b>	tylko w EF 98 netto <b>120,54 brutto</b>				S	
	7	tylko w CU-4, CU-24, CU-14, C-29, CU-32, C-38, C-11 87 netto <b>107,01 brutto</b>						EX
	14	również w CU 103 netto <b>126,69 brutto</b>	tylko w EF 115 netto <b>141,45 brutto</b>				S	
	7	tylko w CU-4, CU-24, CU-14, C-29, CU-32, C-38, C-11 103 netto <b>126,69 brutto</b>						EX
	14	również w CU 145 netto <b>178,35 brutto</b>	tylko w EF 158 netto <b>194,34 brutto</b>				S	
	14	również w CU 138 netto <b>169,74 brutto</b>	tylko w EF 152 netto <b>186,96 brutto</b>				S	
	14	również w CU 153 netto <b>188,19 brutto</b>	tylko w EF 166 netto <b>204,18 brutto</b>				S	
	ZP	114 netto <b>140,22 brutto</b>	tylko w EF 126 netto <b>154,98 brutto</b>				S	

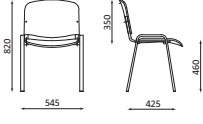











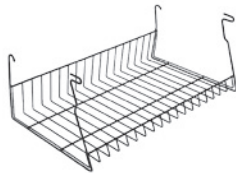

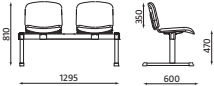

oferta: P – premium, S – standard, EX – express

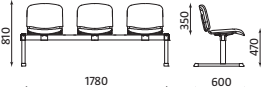
ważne informacje	składowanie w stosie [max. ilość szt.]	objętość kartonu [m <sup>3</sup> ]	ilość w kartonie [szt.]	waga netto 1 szt. [kg]	siedzisko		MODEL wymiary podane w mm	
					szer. [mm]	głęb. [mm]		
<b>REMODEX</b> 	12	paleta: 50	6,65	475	415			ISO plastic alu
								ISO plastic black
								ISO plastic chrome
<b>REMODEX</b> 		paleta: 50	9,45	475	415			ISO T alu (także dla leworęcznych – T/L)
								ISO T black (także dla leworęcznych – T/L)
								ISO T chrome (także dla leworęcznych – T/L)
<b>REMODEX</b>		paleta: 50	8,45	475	415			ISO TE alu (także dla leworęcznych – T/L)
								ISO TE black (także dla leworęcznych – T/L)
								ISO TE chrome (także dla leworęcznych – T/L)
<b>REMODEX</b>		paleta: 50	7,65	475	415			ISO TE wood alu (także dla leworęcznych – T/L)
								ISO TE wood black (także dla leworęcznych – T/L)
								ISO TE wood chrome (także dla leworęcznych – T/L)
<b>REMODEX</b> 	10	paleta: 50	5,30	475	415			ISO wood alu
								ISO wood black
								ISO wood chrome

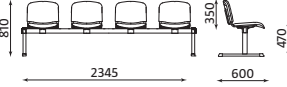

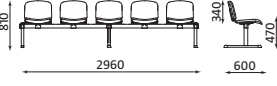
SZCZEGÓŁOWE WYKOŃCZENIE	TERMIN REALIZACJI	CENA MODELU W ZALEŻNOŚCI OD WYKOŃCZENIA [zł]					
		TAPICERKA PODSTAWOWA (C) MICRO (M) SKAJ (V)	OBAN (EF) LUCIA (YB)	NOBLE LUX (NL) MICROFIBRA (CM) SOTI (SI)	CONTRACT (YN) NEXUS (UNY)	OXYGEN (OX)	OFERTA
K02, K05, K36, K53, K30, K31, K59, K51	14	93 netto <b>114,39 brutto</b>					S
K02, K05, K36, K53, K30, K31, K59, K51	14	87 netto <b>107,01 brutto</b>					S
K02, K05, K36, K53, K30, K31, K59, K51	14	100 netto <b>123,00 brutto</b>					S
	14	również w CU 178 netto <b>218,94 brutto</b>	tylko w EF 192 netto <b>236,16 brutto</b>				S
	14	również w CU 173 netto <b>212,79 brutto</b>	tylko w EF 184 netto <b>226,32 brutto</b>				S
	7	tylko w CU-4, CU-24, C-29, CU-32, CU-14, C-38, C-11 173 netto <b>212,79 brutto</b>					EX
	14	również w CU 184 netto <b>226,32 brutto</b>	tylko w EF 198 netto <b>243,54 brutto</b>				S
	7	tylko w CU-4, CU-24, C-29, CU-32, CU-14, C-38, C-11 184 netto <b>226,32 brutto</b>					EX
1.007 (dotyczy pulpitu)	14	również w CU 189 netto <b>232,47 brutto</b>	tylko w EF 202 netto <b>248,46 brutto</b>				S
1.007 (dotyczy pulpitu)	14	również w CU 182 netto <b>223,86 brutto</b>	tylko w EF 196 netto <b>241,08 brutto</b>				S
1.007 (dotyczy pulpitu)	14	również w CU 196 netto <b>241,08 brutto</b>	tylko w EF 209 netto <b>257,07 brutto</b>				S
1.007	14	250 netto <b>307,50 brutto</b>					S
1.007	14	244 netto <b>300,12 brutto</b>					S
1.007	14	256 netto <b>314,88 brutto</b>					S
1.007	14	154 netto <b>189,42 brutto</b>					S
1.007	14	146 netto <b>179,58 brutto</b>					S
1.007	14	160 netto <b>196,80 brutto</b>					S

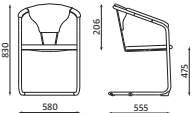
oferta: P – premium, S – standard, EX – express







ważne informacje	składowanie w stosie [max. ilość szt.]	objętość kartonu [m <sup>3</sup> ]	ilość w kartonie [szt.]	waga netto 1 szt. [kg]	siedzisko		MODEL wymiary podane w mm	
					szer. [mm]	głęb. [mm]		
							 	KOSZYK do ISO alu KOSZYK do ISO black KOSZYK do ISO chrome
							 	ISO link alu ISO link black ISO link chrome
<b>REMODEX</b> 		0,15	1	19,40	475	415	 	ISO-2 alu ISO-2 black
<b>REMODEX</b> 		0,18	1	26,15	475	415	 	ISO-3 alu ISO-3 black
<b>REMODEX</b> 		0,18	1	32,90	475	415	 	ISO-4 alu ISO-4 black
<b>REMODEX</b>		0,21	1	41,70	475	415	 	ISO-5 alu ISO-5 black
<b>REMODEX</b>	2	0,38	2	9,20	505	520	 	KELLY chrome



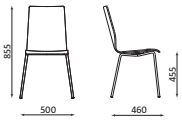

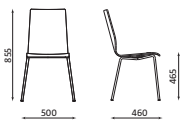
SZCZEGÓŁOWE WYKOŃCZENIE	TERMIN REALIZACJI	CENA MODELU W ZALEŻNOŚCI OD WYKOŃCZENIA [zł]					
		TAPICERKA PODSTAWOWA (C) MICRO (M) SKAJ (V)	OBAN (EF) LUCIA (YB)	NOBLE LUX (NL) MICROFIBRA (CM) SOTI (SI)	CONTRACT (YN) NEXUS (UNY)	OXYGEN (OX)	OFERTA
	14	42 netto <b>51,66 brutto</b>					S
	14	41 netto <b>50,43 brutto</b>					S
	14	50 netto <b>61,50 brutto</b>					S
	14	9 netto <b>11,07 brutto</b>					S
	14	8 netto <b>9,84 brutto</b>					S
	14	10 netto <b>12,30 brutto</b>					S
	21	również w CU 330 netto <b>405,90 brutto</b>	tylko w EF 355 netto <b>436,65 brutto</b>				S
	21	również w CU 314 netto <b>386,22 brutto</b>	tylko w EF 360 netto <b>442,80 brutto</b>				S
	21	również w CU 428 netto <b>526,44 brutto</b>	tylko w EF 468 netto <b>575,64 brutto</b>				S
	21	również w CU 407 netto <b>500,61 brutto</b>	tylko w EF 446 netto <b>548,58 brutto</b>				S
	21	również w CU 536 netto <b>659,28 brutto</b>	tylko w EF 587 netto <b>722,01 brutto</b>				S
	21	również w CU 510 netto <b>627,30 brutto</b>	tylko w EF 561 netto <b>690,03 brutto</b>				S
	21	również w CU 677 netto <b>832,71 brutto</b>	tylko w EF 741 netto <b>911,43 brutto</b>				S
	21	również w CU 639 netto <b>785,97 brutto</b>	tylko w EF 704 netto <b>865,92 brutto</b>				S
1.007, 1.008, 1.010, 1.031	14	również w CU 325 netto <b>399,75 brutto</b>					S

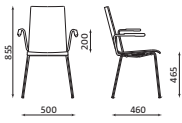
oferta: P – premium, S – standard, EX – express

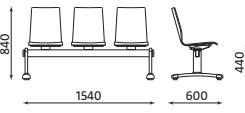
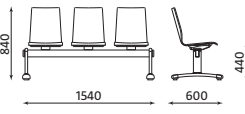
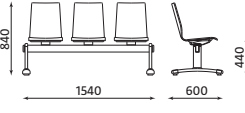
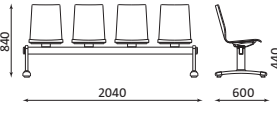
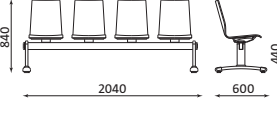
ważne informacje	składowanie w stosie [max. ilość szt.]	objętość kartonu [m <sup>3</sup> ]	ilość w kartonie [szt.]	waga netto 1 szt. [kg]	siedzisko		MODEL wymiary podane w mm	
					szer. [mm]	głęb. [mm]		
<b>REMODEX</b>	4	0,32	4	4,90	395	425	 	LATTE alu
								LATTE chrome
<b>REMODEX</b>	4	0,32	4	5,80	395	425	 	LATTE plus alu
								LATTE plus chrome
<b>REMODEX</b>		0,32	2	7,10	395	425	 	LATTE B plus ARM chrome
		0,2	1	23,00	395	425		LATTE-3 chrome
		0,2	1	24,50	395	425		LATTE-3 seat plus chrome
		0,2	1	24,50	395	425		LATTE-3 plus chrome
		0,2	1	29,00	395	425		LATTE-4 chrome
		0,2	1	31,00	395	425		LATTE-4 seat plus chrome















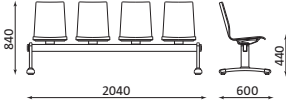
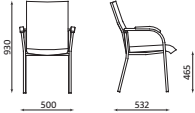

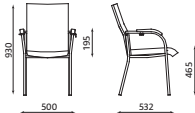

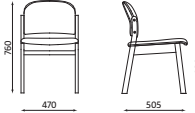

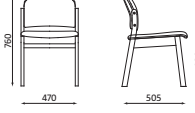

SZCZEGÓLWE WYKOŃCZENIE	TERMIN REALIZACJI	CENA MODELU W ZALEŻNOŚCI OD WYKOŃCZENIA [zł]					
		TAPICERKA PODSTAWOWA (C) MICRO (M) SKAJ (V)	OBAN (EF) LUCIA (YB)	NOBLE LUX (NL) MICROFIBRA (CM) SOTI (SI)	CONTRACT (YN) NEXUS (UNY)	OXYGEN (OX)	OFERTA
DREWNO	21	206 netto <b>253,38 brutto</b>					P
LAMINAT	21	249 netto <b>306,27 brutto</b>					P
DREWNO	14	209 netto <b>257,07 brutto</b>					P
LAMINAT	21	252 netto <b>309,96 brutto</b>					P
1.007, 1.010, 1.033	7	209 netto <b>257,07 brutto</b>					EX
DREWNO	21	233 netto <b>286,59 brutto</b>	243 netto <b>298,89 brutto</b>	249 netto <b>306,27 brutto</b>	255 netto <b>313,65 brutto</b>	263 netto <b>323,49 brutto</b>	P
DREWNO	21	236 netto <b>290,28 brutto</b>	246 netto <b>302,58 brutto</b>	252 netto <b>309,96 brutto</b>	258 netto <b>317,34 brutto</b>	266 netto <b>327,18 brutto</b>	P
1.007, 1.008, 1.010, 1.033	7	tylko w YB-130, YB-026, YB-009, YB-105 364 netto <b>447,72 brutto</b>					EX
1.033	5	tylko w YB-130 364 netto <b>447,72 brutto</b>					
DREWNO	14	1014 netto <b>1247,22 brutto</b>					P
LAMINAT	21	1143 netto <b>1405,89 brutto</b>					P
DREWNO	14	1055 netto <b>1297,65 brutto</b>	1070 netto <b>1316,10 brutto</b>	1080 netto <b>1328,40 brutto</b>	1086 netto <b>1335,78 brutto</b>	P	
DREWNO	14	1092 netto <b>1343,16 brutto</b>	1124 netto <b>1382,52 brutto</b>	1143 netto <b>1405,89 brutto</b>	1159 netto <b>1425,57 brutto</b>	P	
DREWNO	14	1217 netto <b>1496,91 brutto</b>					P
LAMINAT	21	1390 netto <b>1709,70 brutto</b>					P
DREWNO	14	1272 netto <b>1564,56 brutto</b>	1293 netto <b>1590,39 brutto</b>	1306 netto <b>1606,38 brutto</b>	1314 netto <b>1616,22 brutto</b>	P	

drewno: 1.007, 1.040, 1.010, 1.008, 1.016, 1.042, 1.023, 1.031, 1.033, 1.043  
 laminat: H1733, H3389, H3005, H3704, W1000, U303, U630, U321, U999, U773, H3005 horizontal

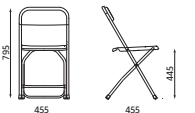
oferta: P – premium, S – standard, EX – express

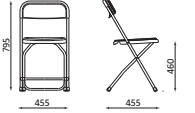
TERMIN REALIZACJI podano w dniach kalendarzowych.  
 ZP – ZA POTWIERDZENIEM – oznacza każdorazowe uzgadnianie terminu realizacji z Działem Handlowym.



ważne informacje	składowanie w stosie [max. ilość szt.]	objętość kartonu [m <sup>3</sup> ]	ilość w kartonie [szt.]	waga netto 1 szt. [kg]	siedzisko		MODEL wymiary podane w mm	
					szer. [mm]	głęb. [mm]		
		0,2	1	31,00	395	425		LATTE-4 plus chrome
<b>REMODEX</b> DŁUŻSZA GWARANCJA	4	0,4	1	8,0	440	450	 	LOCO II chrome
<b>REMODEX</b> DŁUŻSZA GWARANCJA	4	0,4	1	8,0	440	450	 	LOCO II click chrome
<b>REMODEX</b>	4	0,37	4	6,30	480	475	 	MALVA
<b>REMODEX</b>	4	0,37	4	6,10	470	475	 	MALVA click
<b>REMODEX</b>		0,27	1	7,50	480	410	 	PATRIZIA alu
<b>REMODEX</b>							 	PATRIZIA black
<b>REMODEX</b>	20 po złożeniu	0,09	5	3,02	400	400	 	POLYFOLD alu minimalne zamówienie – 1 karton
<b>REMODEX</b>	20 po złożeniu	0,09	5	4,75	400	400	 	POLYFOLD plus alu minimalne zamówienie – 1 karton
							 	POLYFOLD click alu
								POLYFOLD click plus alu



SZCZEGÓLNE WYKOŃCZENIE	TERMIN REALIZACJI	CENA MODELU W ZALEŻNOŚCI OD WYKOŃCZENIA [zł]					
		TAPICERKA PODSTAWOWA (C) MICRO (M) SKAJ (V)	OBAN (EF) LUCIA (YB)	NOBLE LUX (NL) MICROFIBRA (CM) SOTI (SI)	CONTRACT (YN) NEXUS (UNY)	OXYGEN (OX)	OFERTA
DREWNO	14	1322 netto <b>1626,06 brutto</b>	1364 netto <b>1677,72 brutto</b>	1390 netto <b>1709,70 brutto</b>	1411 netto <b>1735,53 brutto</b>		P
DREWNO	14	tylko w M, C 376 netto <b>462,48 brutto</b>	401 netto <b>493,23 brutto</b>	tylko w CM 430 netto <b>528,90 brutto</b>	471 netto <b>579,33 brutto</b>		P
DREWNO	14	tylko w M, C 391 netto <b>480,93 brutto</b>	415 netto <b>510,45 brutto</b>	tylko w CM 445 netto <b>547,35 brutto</b>	486 netto <b>597,78 brutto</b>		P
DREWNO	14	tylko w M, C 290 netto <b>356,70 brutto</b>	307 netto <b>377,61 brutto</b>	351 netto <b>431,73 brutto</b>	370 netto <b>455,10 brutto</b>	433 netto <b>532,59 brutto</b>	P
	14	tylko w M, C 321 netto <b>394,83 brutto</b>	338 netto <b>415,74 brutto</b>	384 netto <b>472,32 brutto</b>	401 netto <b>493,23 brutto</b>	422 netto <b>519,06 brutto</b>	P
	21	również w CU 185 netto <b>227,55 brutto</b>	tylko w EF 198 netto <b>243,54 brutto</b>				S
	ZP	również w CU 179 netto <b>220,17 brutto</b>	tylko w EF 192 netto <b>236,16 brutto</b>				S
K02, K05, K36, K53, K30, K31, K59, K51	14			78 netto <b>95,94 brutto</b>			S
K02, K05, K30, K31, K59, K51 TK02, TK05, TK30, TK31, TK59, TK51	14			115 netto <b>141,45 brutto</b>			S
K02, K05, K36, K53, K30, K31, K59, K51	14			86 netto <b>105,78 brutto</b>			S
K02, K05, K30, K31, K59, K51 TK02, TK05, TK30, TK31, TK59, TK51	14			122 netto <b>150,06 brutto</b>			S









drewno: 1.007, 1.040, 1.010, 1.008, 1.016, 1.042, 1.023, 1.031, 1.033, 1.043

oferta: P – premium, S – standard, EX – express

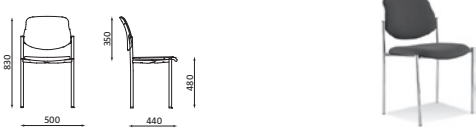
TERMIN REALIZACJI podano w dniach kalendarzowych.

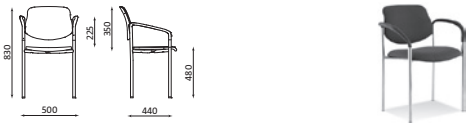
ZP – ZA POTWIERDZENIEM – oznacza każdorazowe uzgadnianie terminu realizacji z Działem Handlowym.

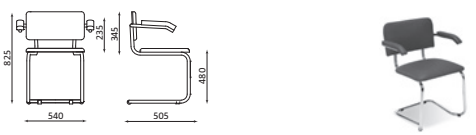
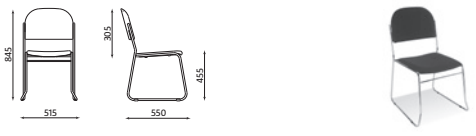
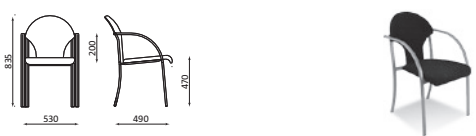

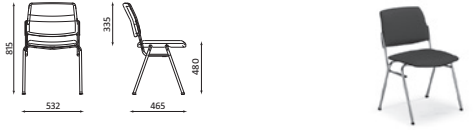
ważne informacje	składowanie w stosie [max. ilość szt.]	objętość kartonu [m³]	ilość w kartonie [szt.]	waga netto 1 szt. [kg]	siedzisko		MODEL wymiary podane w mm	
					szer. [mm]	głęb. [mm]		
	6	0,40	4	5,50	450	460		STYL alu
								STYL black
								STYL chrome
	6	0,45	4	6,85	450	460		STYL ARM alu
								STYL ARM black
								STYL ARM chrome
REMODEX	3	0,30	3	6,20	460	430		SYLWIA S chrome
REMODEX	3	0,43	3	6,40	460	430		SYLWIA S ARM chrome
REMODEX	6	0,40	5	4,90	410	430		VESTA alu
		0,38	4					VESTA chrome
REMODEX	2	0,38	2	7,80	450	490		VISA alu
								VISA chrome
	4	0,4	4	5,00	440	405		V-SIT black
								V-SIT chrome











Produkty posiadają Atest Badań Wytrzymałościowych.

Nowy Styl zastrzega sobie prawo do zmian: konstrukcyjnych, wymiarów, terminów dostaw; usunięcia produktów i zmian w palecie wykończeń.

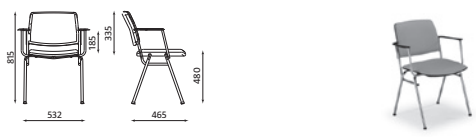
## KRZESŁA I STOŁY DO POCZEKALNI I SAL KONFERENCYJNYCH

SZCZEGÓŁOWE WYKOŃCZENIE	TERMIN REALIZACJI	CENA MODELU W ZALEŻNOŚCI OD WYKOŃCZENIA [zł]					
		TAPICERKA PODSTAWOWA (C) MICRO (M) SKAJ (V)	OBAN (EF) LUCIA (YB)	NOBLE LUX (NL) MICROFIBRA (CM) SOTI (SI)	CONTRACT (YN) NEXUS (UNY)	OXYGEN (OX)	OFERTA
	21	również w CU 126 netto <b>154,98 brutto</b>	tylko w EF 139 netto <b>170,97 brutto</b>				S
	14	również w CU 119 netto <b>146,37 brutto</b>	tylko w EF 131 netto <b>161,13 brutto</b>				S
	14	również w CU 131 netto <b>161,13 brutto</b>	tylko w EF 144 netto <b>177,12 brutto</b>				S
	21	również w CU 146 netto <b>179,58 brutto</b>	tylko w EF 159 netto <b>195,57 brutto</b>				S
	14	również w CU 139 netto <b>170,97 brutto</b>	tylko w EF 151 netto <b>185,73 brutto</b>				S
	7	tylko w C-11, CU-14, C-29, CU-24, CU-32 139 netto <b>170,97 brutto</b>					EX
	14	również w CU 151 netto <b>185,73 brutto</b>	tylko w EF 164 netto <b>201,72 brutto</b>				S
	14	również w CU 135 netto <b>166,05 brutto</b>	tylko w EF 159 netto <b>195,57 brutto</b>				S
	14	również w CU 195 netto <b>239,85 brutto</b>	tylko w EF 215 netto <b>264,45 brutto</b>				S
	21	tylko w C, CU, M 128 netto <b>157,44 brutto</b>	tylko w EF 134 netto <b>164,82 brutto</b>				S
	14	tylko w C, CU, M 144 netto <b>177,12 brutto</b>	tylko w EF 151 netto <b>185,73 brutto</b>				S
	21	również w CU 217 netto <b>266,91 brutto</b>	tylko w EF 230 netto <b>282,90 brutto</b>				S
	14	również w CU 231 netto <b>284,13 brutto</b>	tylko w EF 244 netto <b>300,12 brutto</b>				S
	7	tylko w CU-24, C-29, CU-32, C-11, CU-14 146 netto <b>179,58 brutto</b>					EX
	7	tylko w CU-24, C-29, CU-32, C-11 167 netto <b>205,41 brutto</b>					EX
	5	tylko w CU-14 167 netto <b>205,41 brutto</b>					

oferta: P – premium, S – standard, EX – express

ważne informacje	składowanie w stosie [max. ilość szt.]	objętość kartonu [m <sup>3</sup> ]	ilość w kartonie [szt.]	waga netto 1 szt. [kg]	siedzisko		MODEL wymiary podane w mm	
					szer. [mm]	głęb. [mm]		
 <b>REMODEX</b>	4	0,4	4	5,75	440	405		V-SIT ARM black
								V-SIT ARM chrome
 <b>REMODEX</b>	8	0,37	4	7,00	450	460		WING II.20 alu
								WING II.20 chrome
 <b>REMODEX</b>	8	0,37	4	7,00	450	460		WING II alu
								WING II chrome
<b>REMODEX</b>	8	0,37	4	7,30	450	460		WING II seat plus alu
								WING II seat plus chrome
<b>REMODEX</b>	8	0,37	4	7,50	450	460		WING II plus alu
								WING II plus chrome
<b>REMODEX</b>								<b>WING click</b> wszystkie wersje krzesła <b>WING</b> dostępne są również w opcji click





SZCZEGÓŁOWE WYKOŃCZENIE	TERMIN REALIZACJI	CENA MODELU W ZALEŻNOŚCI OD WYKOŃCZENIA [zł]					OFERTA
		TAPICERKA PODSTAWOWA (C) MICRO (M) SKAJ (V)	OBAN (EF) LUCIA (YB)	NOBLE LUX (NL) MICROFIBRA (CM) SOTI (SI)	CONTRACT (YN) NEXUS (UNY)	OXYGEN (OX)	
	7	tylko w CU-24, C-29, CU-32, C-11, CU-14 167 netto <b>205,41 brutto</b>					EX
	7	tylko w CU-24, C-29, CU-32, C-11 206 netto <b>253,38 brutto</b>					EX
	5	tylko w CU-14 206 netto <b>253,38 brutto</b>					
DREWNO	21	232 netto <b>285,36 brutto</b>					P
LAMINAT	21	275 netto <b>338,25 brutto</b>					
DREWNO	14	247 netto <b>303,81 brutto</b>					P
LAMINAT	21	290 netto <b>356,70 brutto</b>					
DREWNO	21	232 netto <b>285,36 brutto</b>					P
LAMINAT	21	275 netto <b>338,25 brutto</b>					
DREWNO	14	247 netto <b>303,81 brutto</b>					P
LAMINAT	21	290 netto <b>356,70 brutto</b>					
DREWNO	21	258 netto <b>317,34 brutto</b>	263 netto <b>323,49 brutto</b>	266 netto <b>327,18 brutto</b>	268 netto <b>329,64 brutto</b>	272 netto <b>334,56 brutto</b>	P
DREWNO	14	273 netto <b>335,79 brutto</b>	279 netto <b>343,17 brutto</b>	282 netto <b>346,86 brutto</b>	284 netto <b>349,32 brutto</b>	288 netto <b>354,24 brutto</b>	P
DREWNO	21	270 netto <b>332,10 brutto</b>	281 netto <b>345,63 brutto</b>	287 netto <b>353,01 brutto</b>	292 netto <b>359,16 brutto</b>	301 netto <b>370,23 brutto</b>	P
DREWNO	14	286 netto <b>351,78 brutto</b>	297 netto <b>365,31 brutto</b>	303 netto <b>372,69 brutto</b>	308 netto <b>378,84 brutto</b>	317 netto <b>389,91 brutto</b>	P
		dopłata do wersji click: 8 netto <b>9,84 brutto</b>					P















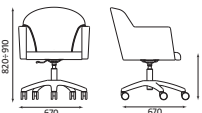







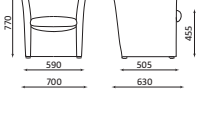

drewno: 1.007, 1.040, 1.010, 1.008, 1.016, 1.042, 1.023, 1.031, 1.033, 1.043  
laminat: H1733, H3389, H3005, H3704, W1000, U303, U630, U321, U999, U773, H3005  
horizontal

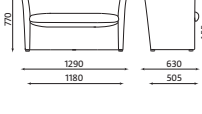
oferta: P – premium, S – standard, EX – express

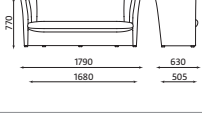
TERMIN REALIZACJI podano w dniach kalendarzowych.

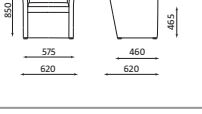
ZP – ZA POTWIERDZENIEM – oznacza każdorazowe uzgadnianie terminu realizacji z Działem Handlowym.

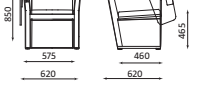









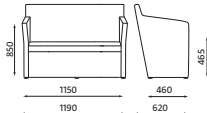

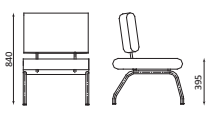

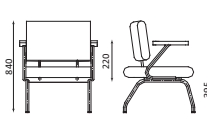

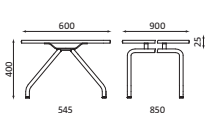

ważne informacje	składowanie w stosie [max. ilość szt.]	objętość kartonu [m <sup>3</sup> ]	ilość w kartonie [szt.]	waga netto 1 szt. [kg]	siedzisko		MODEL wymiary podane w mm	
					szer. [mm]	głęb. [mm]		
		0,38	1	13,30	525	470	 	ATHENA CROSS chrome
		0,44	1	13,70	525	470	 	ATHENA steel33 chrome
 		0,37	1	19,00	425	430	 	ATRIUM MEMORY chrome
 		0,37	1	19,70	425	430	 	ATRIUM MEMORY HR chrome
		0,37	1	16,00	480	500	 	CLUB
		0,68	1	28,60	1066	500	 	CLUB DUO
		0,93	1	38	1570	500	 	CLUB TRIO
		0,38	1	18,70	480	500	 	CLUB SQ
		0,43	1	20,70	480	500	 	CLUB SQ TE

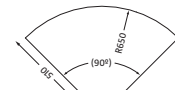

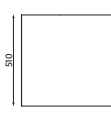
SZCZEGÓLWE WYKOŃCZENIE	TERMIN REALIZACJI	CENA MODELU W ZALEŻNOŚCI OD WYKOŃCZENIA [zł]										
		SKÓRA DWOINA (SP)		SKÓRA LICOWA (SD/LE)		TAPICERKA PODSTAWOWA (C) MICRO (M) SKAJ (V)	SKAJ TG	OBAN (EF) LUCIA (YB)	NOBLE LUX (NL) MICROFIBRA (CM) SOTI (SI)	CONTRACT (YN) NEXUS (UNY)	OXYGEN (OX)	OFERTA
		front tapicerowany skórą	792 netto 974,16 brutto	front tapicerowany skórą	całość tapicerowana skórą							
	14		792 netto 974,16 brutto		905 netto 1113,15 brutto	tylko w V 629 netto 773,67 brutto			tylko w SI 672 netto 826,56 brutto	814 netto 1001,22 brutto	867 netto 1066,41 brutto	P
	14		776 netto 954,48 brutto		889 netto 1093,47 brutto	tylko w V 615 netto 756,45 brutto			tylko w SI 657 netto 808,11 brutto	797 netto 980,31 brutto	846 netto 1040,58 brutto	P
	14	1015 netto 1248,45 brutto	1148 netto 1412,04 brutto	1425 netto 1752,75 brutto	tylko w V 880 netto 1082,40 brutto	896 netto 1102,08 brutto	tylko w EF 896 netto 1102,08 brutto	tylko w SI 958 netto 1178,34 brutto	1013 netto 1245,99 brutto			P
	14	1136 netto 1397,28 brutto	1291 netto 1587,93 brutto	1571 netto 1932,33 brutto	tylko w V 980 netto 1205,40 brutto	996 netto 1225,08 brutto	tylko w EF 996 netto 1225,08 brutto	tylko w SI 1059 netto 1302,57 brutto	1134 netto 1394,82 brutto			P
	14	536 netto 659,28 brutto	633 netto 778,59 brutto	1077 netto 1324,71 brutto	tylko w V 395 netto 485,85 brutto	415 netto 510,45 brutto	tylko w EF 428 netto 526,44 brutto					S
	7	tylko w V-46, V-82, V-98, V-04 395 netto 485,85 brutto										EX
	14	931 netto 1145,13 brutto	1108 netto 1362,84 brutto	1710 netto 2103,30 brutto	tylko w V 671 netto 825,33 brutto	696 netto 856,08 brutto	tylko w EF 724 netto 890,52 brutto					S
	14	1220 netto 1500,60 brutto	1445 netto 1777,35 brutto	2259 netto 2778,57 brutto	tylko w V 886 netto 1089,78 brutto	903 netto 1110,69 brutto	tylko w EF 957 netto 1177,11 brutto					S
	21	645 netto 793,35 brutto	741 netto 911,43 brutto	1184 netto 1456,32 brutto	tylko w V 503 netto 618,69 brutto	536 netto 659,28 brutto	tylko w EF 536 netto 659,28 brutto	tylko w SI 575 netto 707,25 brutto	650 netto 799,50 brutto	703 netto 864,69 brutto		P
	21	722 netto 888,06 brutto	817 netto 1004,91 brutto	1262 netto 1552,26 brutto	tylko w V 580 netto 713,40 brutto	614 netto 755,22 brutto	tylko w EF 614 netto 755,22 brutto	tylko w SI 651 netto 800,73 brutto	727 netto 894,21 brutto	780 netto 959,40 brutto		P

oferta: P – premium, S – standard, EX – express

ważne informacje	składowanie w stosie [max. ilość szt.]	objętość kartonu [m <sup>3</sup> ]	ilość w kartonie [szt.]	waga netto 1 szt. [kg]	siedzisko		MODEL wymiary podane w mm	
					szer. [mm]	głęb. [mm]		
<b>REMODEX</b>		0,68	1	28,60	1066	500	 	CLUB SQ DUO
<b>REMODEX</b> DŁUŻSZA GWARANCJA		0,3	1	10,80	540	590	 	CONECT II chrome
<b>REMODEX</b> DŁUŻSZA GWARANCJA		0,4	1	14,00	540	590	 	CONECT II ARM chrome
<b>REMODEX</b>			1	13,60			 	CONECT table
<b>REMODEX</b>			1	5,05			 	CONECT II łącznik 60
<b>REMODEX</b>			1	5,50			 	CONECT II łącznik 90
<b>REMODEX</b>			1	5,75			 	CONECT II łącznik 51x51
								CONECT LINK (2 szt. w komplecie)
<b>REMODEX</b>		0,3	1	11,80	500	450	 	HELLO! 4L alu HELLO! 4L chrome











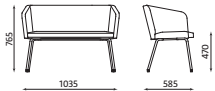

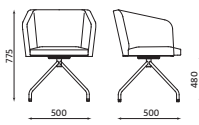

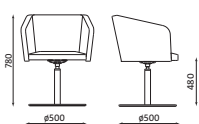

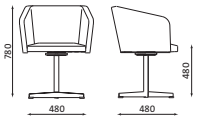
Produkty posiadają Atest Badań Wytrzymałościowych.

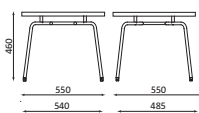
Nowy Styl zastrzega sobie prawo do zmian: konstrukcyjnych, wymiarów, terminów dostaw; usunięcia produktów i zmian w palecie wykończeń.

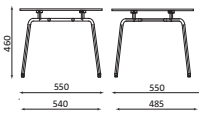
SZCZEGÓLWE WYKOŃCZENIE	TERMIN REALIZACJI	CENA MODELU W ZALEŻNOŚCI OD WYKOŃCZENIA [zł]										
		SKÓRA DWOINA (SP)		SKÓRA LICOWA (SD/LE)		TAPICERKA PODSTAWOWA (C) MICRO (M) SKAJ (V)	SKAJ TG	OBAN (EF) LUCIA (YB)	NOBLE LUX (NL) MICROFIBRA (CM) SOTI (SI)	CONTRACT (YN) NEXUS (UNY)	OXYGEN (OX)	OFERTA
		front tapicerowany skórą	front tapicerowany skórą	całość tapicerowana skórą								
	21	1061 netto <b>1305,03 brutto</b>	1238 netto <b>1522,74 brutto</b>	1839 netto <b>2261,97 brutto</b>	tylko w V 802 netto <b>986,46 brutto</b>	860 netto <b>1057,80 brutto</b>	tylko w EF 860 netto <b>1057,80 brutto</b>	tylko w SI 903 netto <b>1110,69 brutto</b>	1079 netto <b>1327,17 brutto</b>	1131 netto <b>1391,13 brutto</b>	P	
	21		847 netto <b>1041,81 brutto</b>		tylko w V 578 netto <b>710,94 brutto</b>		tylko w EF 587 netto <b>722,01 brutto</b>		685 netto <b>842,55 brutto</b>	727 netto <b>894,21 brutto</b>	P	
	21		957 netto <b>1177,11 brutto</b>		tylko w V 689 netto <b>847,47 brutto</b>		tylko w EF 698 netto <b>858,54 brutto</b>		795 netto <b>977,85 brutto</b>	837 netto <b>1029,51 brutto</b>	P	
	21	298 netto <b>366,54 brutto</b>									P	
	21	129 netto <b>158,67 brutto</b>									P	
	21	153 netto <b>188,19 brutto</b>									P	
	21	99 netto <b>121,77 brutto</b>									P	
		25 netto <b>30,75 brutto</b>									P	
	21	696 netto <b>856,08 brutto</b>	822 netto <b>1011,06 brutto</b>	980 netto <b>1205,40 brutto</b>	tylko w M, V 569 netto <b>699,87 brutto</b>				686 netto <b>843,78 brutto</b>	739 netto <b>908,97 brutto</b>	P	
	21	718 netto <b>883,14 brutto</b>	845 netto <b>1039,35 brutto</b>	1002 netto <b>1232,46 brutto</b>	tylko w M, V 592 netto <b>728,16 brutto</b>				709 netto <b>872,07 brutto</b>	762 netto <b>937,26 brutto</b>	P	

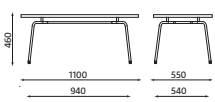
oferta: P – premium, S – standard, EX – express

ważne informacje	składowanie w stosie [max. ilość szt.]	objętość kartonu [m <sup>3</sup> ]	ilość w kartonie [szt.]	waga netto 1 szt. [kg]	siedzisko		MODEL wymiary podane w mm	
					szer. [mm]	głęb. [mm]		
REMODEX		0,68	1	18,00	1000	450	 	HELLO! 4L DUO alu
								HELLO! 4L DUO chrome
REMODEX		0,31	1	13,50	500	450	 	HELLO! 4S alu
								HELLO! 4S chrome
REMODEX		0,32	1	24,80	490	450	 	HELLO! 1S chrome
								HELLO! 1S CROSS chrome
		0,32	1	24,80	490	450	 	HELLO! 1S CROSS chrome
								HELLO! TABLE MA alu
REMODEX		0,2	1	8,60			 	HELLO! TABLE MA chrome
								HELLO! TABLE GL alu
REMODEX		0,2	1	10,70			 	HELLO! TABLE GL chrome
								HELLO! TABLE DUO MA alu
REMODEX		0,4	1	14,55			 	HELLO! TABLE DUO MA chrome









Produkty posiadają Atest Badań Wytrzymałościowych.

Nowy Styl zastrzega sobie prawo do zmian: konstrukcyjnych, wymiarów, terminów dostaw; usunięcia produktów i zmian w palecie wykończeń.

SZCZEGÓŁOWE WYKOŃCZENIE	TERMIN REALIZACJI	CENA MODELU W ZALEŻNOŚCI OD WYKOŃCZENIA [zł]										
		SKÓRA DWOINA (SP)		SKÓRA LICOWA (SD/LE)		TAPICERKA PODSTAWOWA (C) MICRO (M) SKAJ (V)	SKAJ TG	OBAN (EF) LUCIA (VB)	NOBLE LUX (NL) MICROFIBRA (CM) SOTI (SI)	CONTRACT (YN) NEXUS (UNY)	OXYGEN (OX)	OFERTA
		front tapicerowany skórą	front tapicerowany skórą	całość tapicerowana skórą								
	21	1035 netto <b>1273,05 brutto</b>	1237 netto <b>1521,51 brutto</b>	1468 netto <b>1805,64 brutto</b>	tylko w M, V 827 netto <b>1017,21 brutto</b>				994 netto <b>1222,62 brutto</b>	1046 netto <b>1286,58 brutto</b>	P	
	21	1066 netto <b>1311,18 brutto</b>	1269 netto <b>1560,87 brutto</b>	1500 netto <b>1845,00 brutto</b>	tylko w M, V 858 netto <b>1055,34 brutto</b>				1025 netto <b>1260,75 brutto</b>	1078 netto <b>1325,94 brutto</b>	P	
	21	785 netto <b>965,55 brutto</b>	912 netto <b>1121,76 brutto</b>	1069 netto <b>1314,87 brutto</b>	tylko w M, V 659 netto <b>810,57 brutto</b>				775 netto <b>953,25 brutto</b>	828 netto <b>1018,44 brutto</b>	P	
	21	808 netto <b>993,84 brutto</b>	935 netto <b>1150,05 brutto</b>	1094 netto <b>1345,62 brutto</b>	tylko w M, V 682 netto <b>838,86 brutto</b>				800 netto <b>984,00 brutto</b>	852 netto <b>1047,96 brutto</b>	P	
	21		1309 netto <b>1610,07 brutto</b>	1466 netto <b>1803,18 brutto</b>	tylko w M, V 1057 netto <b>1300,11 brutto</b>				1174 netto <b>1444,02 brutto</b>	1227 netto <b>1509,21 brutto</b>	P	
	21		998 netto <b>1227,54 brutto</b>	1155 netto <b>1420,65 brutto</b>	tylko w M, V 746 netto <b>917,58 brutto</b>				903 netto <b>1110,69 brutto</b>	956 netto <b>1175,88 brutto</b>	P	
	21	blat melamina 270 netto <b>332,10 brutto</b>									P	
	21	blat melamina 302 netto <b>371,46 brutto</b>									P	
	21	blat szkło przezroczyste 569 netto <b>699,87 brutto</b>									P	
		blat szkło matowe 633 netto <b>778,59 brutto</b>										
	21	blat szkło przezroczyste 600 netto <b>738,00 brutto</b>									P	
		blat szkło matowe 664 netto <b>816,72 brutto</b>										
	21	blat melamina 340 netto <b>418,20 brutto</b>									P	
	21	blat melamina 387 netto <b>476,01 brutto</b>									P	

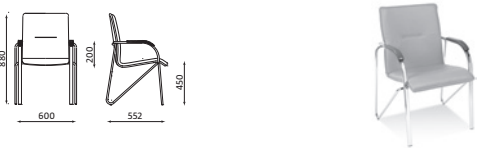
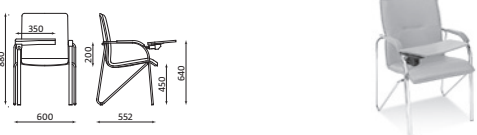
oferta: P – premium, S – standard, EX – express

ważne informacje	składowanie w stosie [max. ilość szt.]	objętość kartonu [m <sup>3</sup> ]	ilość w kartonie [szt.]	waga netto 1 szt. [kg]	siedzisko		MODEL wymiary podane w mm	
					szer. [mm]	głęb. [mm]		
<b>REMODEX</b>		0,4	1	19,05				HELLO! TABLE DUO GL alu
								HELLO! TABLE DUO GL chrome
<b>REMODEX</b> 		0,41	1	8,30	450	440		NEO LUX 4L ARM chrome
<b>REMODEX</b>	4	0,36	2	8,00	460	460		SAMBA alu
								SAMBA chrome
								SAMBA kwarc
<b>REMODEX</b>		0,34	1	8,80	460	460		SAMBA TE alu (także dla leworęcznych – TE/L)
								SAMBA TE chrome (także dla leworęcznych – TE/L)
<b>REMODEX</b>	4	0,36	2	7,80	445	460		SAMBA wood alu
								SAMBA wood chrome
<b>REMODEX</b>	4	0,34	2	8,00	445	460		SAMBA NET chrome



Produkty posiadają Atest Badań Wytrzymałościowych.

Nowy Styl zastrzega sobie prawo do zmian: konstrukcyjnych, wymiarów, terminów dostaw; usunięcia produktów i zmian w paletce wykończeń.





SZCZEGÓŁOWE WYKOŃCZENIE	TERMIN REALIZACJI	CENA MODELU W ZALEŻNOŚCI OD WYKOŃCZENIA [zł]										
		SKÓRA DWOINA (SP)		SKÓRA LICOWA (SD/LE)		TAPICERKA PODSTAWOWA (C) MICRO (M) SKAJ (V)	SKAJ TG	OBAN (EF) LUCIA (VB)	NOBLE LUX (NL) MICROFIBRA (CM) SOTI (SI)	CONTRACT (YN) NEXUS (UNY)	OXYGEN (OX)	OFERTA
		front tapicerowany skórą	front tapicerowany skórą	całość tapicerowana skórą								
	21	blat szkło przeźroczyste 765 netto <b>940,95 brutto</b>										P
	21	blat szkło matowe 872 netto <b>1072,56 brutto</b>										P
	21	blat szkło przeźroczyste 813 netto <b>999,99 brutto</b>										P
	21	blat szkło matowe 919 netto <b>1130,37 brutto</b>										P
	21	532 netto <b>654,36 brutto</b>	604 netto <b>742,92 brutto</b>	699 netto <b>859,77 brutto</b>				tylko w NL, CM 488 netto <b>600,24 brutto</b>	522 netto <b>642,06 brutto</b>	564 netto <b>693,72 brutto</b>	P	
DREWNO	21	354 netto <b>435,42 brutto</b>	430 netto <b>528,90 brutto</b>	503 netto <b>618,69 brutto</b>	254 netto <b>312,42 brutto</b>		278 netto <b>341,94 brutto</b>	tylko w SI 310 netto <b>381,30 brutto</b>	347 netto <b>426,81 brutto</b>	389 netto <b>478,47 brutto</b>	P	
DREWNO	14	367 netto <b>451,41 brutto</b>	440 netto <b>541,20 brutto</b>	515 netto <b>633,45 brutto</b>	263 netto <b>323,49 brutto</b>		289 netto <b>355,47 brutto</b>	tylko w SI 322 netto <b>396,06 brutto</b>	360 netto <b>442,80 brutto</b>	402 netto <b>494,46 brutto</b>	P	
1.007, 1.008, 1.010, 1.033	7	tylko w V-46, V-17, V-49, V-04, V-82, V-98 263 netto <b>323,49 brutto</b>										EX
1.008	5	tylko w V-17, V-04 263 netto <b>323,49 brutto</b>										
1.007, 1.008, 1.010, 1.033	7	tylko w V-46, V-17, V-49, V-04, V-82, V-98 254 netto <b>312,42 brutto</b>										EX
	21	431 netto <b>530,13 brutto</b>	506 netto <b>622,38 brutto</b>	579 netto <b>712,17 brutto</b>	329 netto <b>404,67 brutto</b>		354 netto <b>435,42 brutto</b>	tylko w SI 387 netto <b>476,01 brutto</b>	424 netto <b>521,52 brutto</b>	466 netto <b>573,18 brutto</b>	P	
	21	443 netto <b>544,89 brutto</b>	516 netto <b>634,68 brutto</b>	591 netto <b>726,93 brutto</b>	340 netto <b>418,20 brutto</b>		365 netto <b>448,95 brutto</b>	tylko w SI 398 netto <b>489,54 brutto</b>	435 netto <b>535,05 brutto</b>	477 netto <b>586,71 brutto</b>	P	
DREWNO	21	306 netto <b>376,38 brutto</b>										P
DREWNO	14	317 netto <b>389,91 brutto</b>										P
	14	393 netto <b>483,39 brutto</b>	431 netto <b>530,13 brutto</b>		352 netto <b>432,96 brutto</b>		366 netto <b>450,18 brutto</b>	tylko w SI 382 netto <b>469,86 brutto</b>	392 netto <b>482,16 brutto</b>	518 netto <b>637,14 brutto</b>	P	



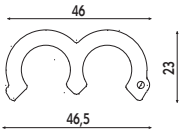

drewno: 1.007, 1.040, 1.010, 1.008, 1.016, 1.042, 1.023, 1.031, 1.033, 1.043

oferta: P – premium, S – standard, EX – express

TERMIN REALIZACJI podano w dniach kalendarzowych.

ZP – ZA POTWIERDZENIEM – oznacza każdorazowe uzgadnianie terminu realizacji z Działem Handlowym.

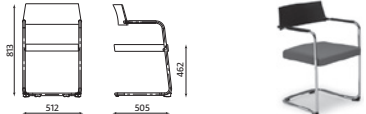
ważne informacje	składowanie w stosie [max. ilość szt.]	objętość kartonu [m <sup>3</sup> ]	ilość w kartonie [szt.]	waga netto 1 szt. [kg]	siedzisko		MODEL wymiary podane w mm		
					szer. [mm]	głęb. [mm]			
									<b>SAMBA link</b> do połączenia tylnych nóg w 2 punktach (2 sztuki w komplecie)

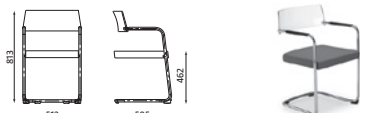
ważne informacje	składowanie w stosie [max. ilość szt.]	objętość kartonu [m <sup>3</sup> ]	ilość w kartonie [szt.]	waga netto 1 szt. [kg]	siedzisko		MODEL wymiary podane w mm	
					szer. [mm]	głęb. [mm]		
	3	0,32	2	8,8	475	460		WAIT PP alu
								WAIT PP chrome
	3	0,32	2	8,8	475	460		WAIT PC alu
								WAIT PC chrome













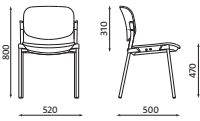

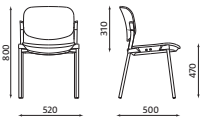
SZCZEGÓŁOWE WYKOŃCZENIE	TERMIN REALIZACJI	CENA MODELU W ZALEŻNOŚCI OD WYKOŃCZENIA [zł]											
		SKÓRA DWOINA (SP)		SKÓRA LICOWA (SD/LE)			TAPICERKA PODSTAWOWA (C) MICRO (M) SKAJ (V)	SKAJ TG	OBAN (EF) LUCIA (YB)	NOBLE LUX (NL) MICROFIBRA (CM) SOTI (SI)	CONTRACT (YN) NEXUS (UNY)	OXYGEN (OX)	OFERTA
		front tapicerowany skórą	całość tapicerowana skórą	front tapicerowany skórą	całość tapicerowana skórą								
	14	cena kompletu 8 netto <b>9,84 brutto</b>										P	

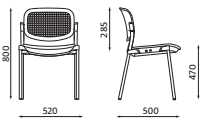
WAIT

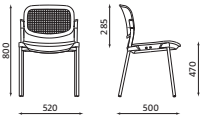
TERMIN REALIZACJI	CENA MODELU W ZALEŻNOŚCI OD WYKOŃCZENIA [zł]						OFERTA
	SKÓRA LICOWA (SD/LE)	MICRO (M) SKAJ (V)	OBAN (EF) LUCIA (YB)	NOBLE LUX (NL) MICROFIBRA (CM) SOTI (SI)	CONTRACT (YN) NEXUS (UNY)	OXYGEN (OX)	
21	552 netto <b>678,96 brutto</b>	457 netto <b>562,11 brutto</b>	468 netto <b>575,64 brutto</b>	473 netto <b>581,79 brutto</b>	489 netto <b>601,47 brutto</b>	499 netto <b>613,77 brutto</b>	P
21	597 netto <b>734,31 brutto</b>	502 netto <b>617,46 brutto</b>	513 netto <b>630,99 brutto</b>	518 netto <b>637,14 brutto</b>	534 netto <b>656,82 brutto</b>	544 netto <b>669,12 brutto</b>	P
21	596 netto <b>733,08 brutto</b>	501 netto <b>616,23 brutto</b>	512 netto <b>629,76 brutto</b>	517 netto <b>635,91 brutto</b>	533 netto <b>655,59 brutto</b>	543 netto <b>667,89 brutto</b>	P
21	641 netto <b>788,43 brutto</b>	546 netto <b>671,58 brutto</b>	557 netto <b>685,11 brutto</b>	562 netto <b>691,26 brutto</b>	578 netto <b>710,94 brutto</b>	588 netto <b>723,24 brutto</b>	P

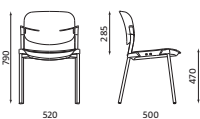
oferta: P – premium, S – standard, EX – express

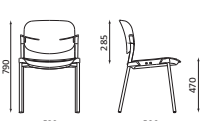
ważne informacje	składowanie w stosie [max. ilość szt.]	objętość kartonu [m <sup>3</sup> ]	ilość w kartonie [szt.]	waga netto 1 szt. [kg]	siedzisko		MODEL wymiary podane w mm	
					szer. [mm]	głęb. [mm]		
	5	0,46	4	5,90	460	480		STEP – 31 BL – FL BL – NA
								STEP – 31 BL – FL GR – NA
								STEP – 31 BL – FL CR – NA
	5	0,46	4	5,90	460	480		STEP – 31 GR – FL BL – NA
								STEP – 31 GR – FL GR – NA
								STEP – 31 GR – FL CR – NA
	5	0,46	4	5,50	460	480		STEP – 32 BL – FL BL – NA
								STEP – 32 BL – FL GR – NA
								STEP – 32 BL – FL CR – NA
	5	0,46	4	5,50	460	480		STEP – 32 GR – FL BL – NA
								STEP – 32 GR – FL GR – NA
								STEP – 32 GR – FL CR – NA
	5	0,36	4	5,40	450	460		STEP – 33 BL – FL BL – NA
								STEP – 33 BL – FL GR – NA
								STEP – 33 BL – FL CR – NA
	5	0,36	4	5,40	450	460		STEP – 33 GR – FL BL – NA
								STEP – 33 GR – FL GR – NA
								STEP – 33 GR – FL CR – NA

\*Certyfikat REMODEX dotyczy również wersji z podłokietnikami oraz wersji CLICK

#### Siedzisko i oparcie

31 – tapicerowane siedzisko i oparcie

32 – tapicerowane siedzisko i oparcie z siatki

33 – siedzisko i oparcie z tworzywa sztucznego

BL (po cyfrze) – elementy z tworzywa sztucznego w kolorze czarnym

GR (po cyfrze) – elementy z tworzywa sztucznego w kolorze szarym RAL 7045

Np. 32GR – tapicerowane siedzisko, oparcie z siatki, elementy z tworzywa sztucznego w kolorze szarym RAL 7045 (podłokietniki, pulpit oraz kółka jeździące)

#### Rama

FL – 4 nogi

BL (po symbolu FL) – rama w kolorze czarnym

GR (po symbolu FL) – rama w kolorze szarym RAL 7045

CR (po symbolu FL) – rama chromowana

NA – wersja bez podłokietników

ARM – wersja z podłokietnikami (kolor identyczny jak siedzisko i oparcie)

RL – rama na kółkach (kolor identyczny jak siedzisko i oparcie)

TR – pulpit dla praworęcznych (kolor identyczny jak siedzisko i oparcie)

TL – pulpit dla leworęcznych (kolor identyczny jak siedzisko i oparcie)

CLICK – łącznik krzesła, dotyczy wszystkich wersji z wyjątkiem RL oraz ławek



→ STEP – 33 BL – FL CR – ARM – TR



→ STEP – 32 GR – FL GR – RL GR – ARM



Produkty posiadają Atest Badań Wytrzymałościowych.

Nowy Styl zastrzega sobie prawo do zmian: konstrukcyjnych, wymiarów, terminów dostaw; usunięcia produktów i zmian w paletce wykończeń.

TERMIN REALIZACJI	SIEDZISKO I OPARCIE	RAMA	PODŁOKIETNIKI	CENA MODELU W ZALEŻNOŚCI OD WYKOŃCZENIA [zł]					OFERTA
				TAP. PODST. (C) MICRO (M) SKAJ (V)	OBAN (EF) LUCIA (YB)	SOTI (SI)	CONTRACT (YN) NEXUS (UNY)	OXYGEN (OX)	
21	tapicerowane [31] CZARNE PP	4 nogi – czarne [FL BL]	bez podłokietników [NA]	271 netto <b>333,33 brutto</b>	279 netto <b>343,17 brutto</b>	291 netto <b>357,93 brutto</b>	303 netto <b>372,69 brutto</b>	324 netto <b>398,52 brutto</b>	P
		4 nogi – szare [FL GR]		278 netto <b>341,94 brutto</b>	285 netto <b>350,55 brutto</b>	298 netto <b>366,54 brutto</b>	309 netto <b>380,07 brutto</b>	330 netto <b>405,90 brutto</b>	P
		4 nogi – chrome [FL CR]		294 netto <b>361,62 brutto</b>	302 netto <b>371,46 brutto</b>	314 netto <b>386,22 brutto</b>	326 netto <b>400,98 brutto</b>	347 netto <b>426,81 brutto</b>	P
21	tapicerowane [31] SZARE PP	4 nogi – czarne [FL BL]		293 netto <b>360,39 brutto</b>	301 netto <b>370,23 brutto</b>	313 netto <b>384,99 brutto</b>	325 netto <b>399,75 brutto</b>	346 netto <b>425,58 brutto</b>	P
		4 nogi – szare [FL GR]		300 netto <b>369,00 brutto</b>	307 netto <b>377,61 brutto</b>	320 netto <b>393,60 brutto</b>	331 netto <b>407,13 brutto</b>	352 netto <b>432,96 brutto</b>	P
		4 nogi – chrome [FL CR]		317 netto <b>389,91 brutto</b>	324 netto <b>398,52 brutto</b>	336 netto <b>413,28 brutto</b>	348 netto <b>428,04 brutto</b>	369 netto <b>453,87 brutto</b>	P
21	siatka [32] CZARNE PP	4 nogi – czarne [FL BL]		294 netto <b>361,62 brutto</b>	302 netto <b>371,46 brutto</b>	314 netto <b>386,22 brutto</b>	326 netto <b>400,98 brutto</b>	347 netto <b>426,81 brutto</b>	P
		4 nogi – szare [FL GR]		304 netto <b>373,92 brutto</b>	311 netto <b>382,53 brutto</b>	324 netto <b>398,52 brutto</b>	335 netto <b>412,05 brutto</b>	356 netto <b>437,88 brutto</b>	P
		4 nogi – chrome [FL CR]		315 netto <b>387,45 brutto</b>	323 netto <b>397,29 brutto</b>	335 netto <b>412,05 brutto</b>	347 netto <b>426,81 brutto</b>	368 netto <b>452,64 brutto</b>	P
21	siatka [32] SZARE PP	4 nogi – czarne [FL BL]		308 netto <b>378,84 brutto</b>	315 netto <b>387,45 brutto</b>	328 netto <b>403,44 brutto</b>	340 netto <b>418,20 brutto</b>	361 netto <b>444,03 brutto</b>	P
		4 nogi – szare [FL GR]		318 netto <b>391,14 brutto</b>	325 netto <b>399,75 brutto</b>	338 netto <b>415,74 brutto</b>	349 netto <b>429,27 brutto</b>	370 netto <b>455,10 brutto</b>	P
		4 nogi – chrome [FL CR]		329 netto <b>404,67 brutto</b>	336 netto <b>413,28 brutto</b>	349 netto <b>429,27 brutto</b>	361 netto <b>444,03 brutto</b>	382 netto <b>469,86 brutto</b>	P
21	tworzywo sztuczne [33] CZARNE PP	4 nogi – czarne [FL BL]		251 netto <b>308,73 brutto</b>					P
		4 nogi – szare [FL GR]		261 netto <b>321,03 brutto</b>					P
		4 nogi – chrome [FL CR]		272 netto <b>334,56 brutto</b>					P
21	tworzywo sztuczne [33] SZARE PP	4 nogi – czarne [FL BL]	262 netto <b>322,26 brutto</b>					P	
		4 nogi – szare [FL GR]	271 netto <b>333,33 brutto</b>					P	
		4 nogi – chrome [FL CR]	278 netto <b>341,94 brutto</b>					P	

## CENA DODATKÓW

RAMA NA KÓŁKACH [RL]	czarna lub szara	89 netto	<b>109,47 brutto</b>
PODŁOKIETNIKI [ARM]	czarne	46 netto	<b>56,58 brutto</b>
	szare	64 netto	<b>78,72 brutto</b>
PULPIT PRAWY [TR]	czarny	154 netto	<b>189,42 brutto</b>
	szary	209 netto	<b>257,07 brutto</b>
PULPIT LEWY [TL]	czarny	154 netto	<b>189,42 brutto</b>
	szary	209 netto	<b>257,07 brutto</b>
WÓZEK		250 netto	<b>307,50 brutto</b>
CLICK		28 netto	<b>34,44 brutto</b>













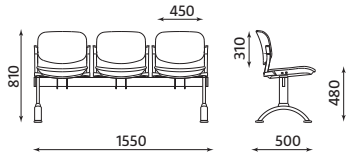

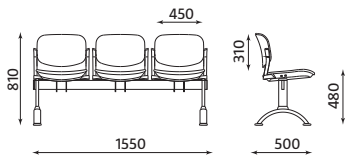

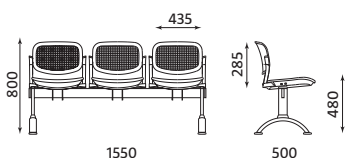
→ WÓZEK

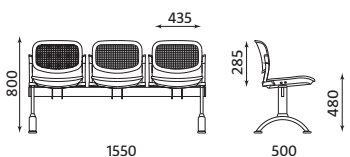
oferta: P – premium, S – standard, EX – express

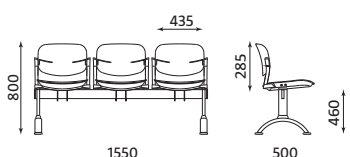
TERMIN REALIZACJI podano w dniach kalendarzowych.

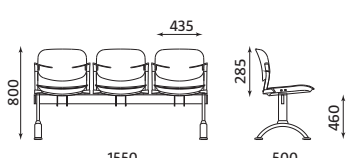
ZP – ZA POTWIERDZENIEM – oznacza każdorazowe uzgadnianie terminu realizacji z Działem Handlowym.

ważne informacje	objętość kartonu [m <sup>3</sup> ]	ilość w kartonie [szt.]	waga netto 1 szt. [kg]	siedzisko		<b>MODEL</b> wymiary podane w mm	
				szer. [mm]	głęb. [mm]		
	0,22	1	23,00	460	480		STEP – 331 BL – FR BL
							STEP – 331 BL – FR GR
							STEP – 331 BL – FR CR
	0,22	1	23,00	460	480		STEP – 331 GR – FR BL
							STEP – 331 GR – FR GR
							STEP – 331 GR – FR CR
	0,22	1	23,00	460	480		STEP – 332 BL – FR BL
							STEP – 332 BL – FR GR
							STEP – 332 BL – FR CR
	0,22	1	23,00	460	480		STEP – 332 GR – FR BL
							STEP – 332 GR – FR GR
							STEP – 332 GR – FR CR
	0,22	1	23,00	450	460		STEP – 333 BL – FR BL
							STEP – 333 BL – FR GR
							STEP – 333 BL – FR CR
	0,22	1	23,00	450	460		STEP – 333 GR – FR BL
							STEP – 333 GR – FR GR
							STEP – 333 GR – FR CR
							Stolik dla ławek [T]

\*Certyfikat REMODEX dotyczy również wersji ławki ze stolikiem

333, 433 – pierwsza cyfra oznacza liczbę miejsc, dwie następne typ siedziska i oparcia  
 431 – cztery miejsca, tapicerowane siedzisko i oparcie  
 432 – cztery miejsca, tapicerowane siedzisko i oparcie z siatki  
 433 – cztery miejsca, siedzisko i oparcie z tworzywa sztucznego  
 BL (po cyfrze) – elementy z tworzywa sztucznego w kolorze czarnym  
 GR (po cyfrze) – elementy z tworzywa sztucznego w kolorze szarym RAL 7045  
 Np. 432GR – cztery miejsca, tapicerowane siedzisko, oparcie z siatki, elementy z tworzywa sztucznego w kolorze szarym RAL 7045 (osłona siedziska i oparcia, rama)













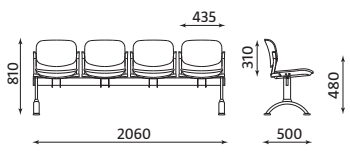

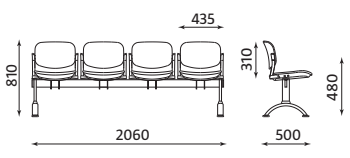
FR – rama  
 BL (po symbolu FR) – nogi ławki w kolorze czarnym  
 GR (po symbolu FR) – nogi ławki w kolorze szarym RAL 7045  
 CR (po symbolu FR) – chromowane nogi ławki  
 T – stolik zamiast siedziska  
 Np. Step – 333 GR – FR GR – T

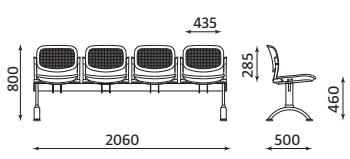

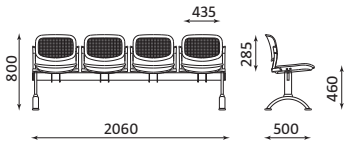
Produkty posiadają Atest Badań Wytrzymałościowych.  
 Nowy Styl zastrzega sobie prawo do zmian: konstrukcyjnych, wymiarów, terminów dostaw; usunięcia produktów i zmian w palecie wykończeń.

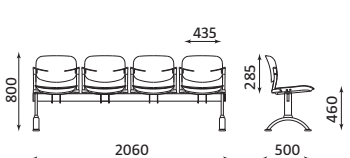
TERMIN REALIZACJI	SIEDZISKO I OPARCIE	RAMA	SIEDZISKO	CENA MODELU W ZALEŻNOŚCI OD WYKOŃCZENIA [zł]					OFERTA
				TAP. PODST. (C) MICRO (M) SKAJ (V)	OBAN (EF) LUCIA (YB)	SOTI (SI)	CONTRACT (YN) NEXUS (UNY)	OXYGEN (OX)	
21	tapicerowane [31] CZARNE PP	czarne nogi [FR BL]	3	1224 netto <b>1505,52 brutto</b>	1245 netto <b>1531,35 brutto</b>	1281 netto <b>1575,63 brutto</b>	1314 netto <b>1616,22 brutto</b>	1374 netto <b>1690,02 brutto</b>	P
		szare nogi [FR GR]		1241 netto <b>1526,43 brutto</b>	1262 netto <b>1552,26 brutto</b>	1298 netto <b>1596,54 brutto</b>	1331 netto <b>1637,13 brutto</b>	1391 netto <b>1710,93 brutto</b>	P
		chromowane nogi [FR CR]		1328 netto <b>1633,44 brutto</b>	1349 netto <b>1659,27 brutto</b>	1385 netto <b>1703,55 brutto</b>	1418 netto <b>1744,14 brutto</b>	1478 netto <b>1817,94 brutto</b>	P
21	tapicerowane [31] SZARE PP	czarne nogi [FR BL]		1262 netto <b>1552,26 brutto</b>	1283 netto <b>1578,09 brutto</b>	1319 netto <b>1622,37 brutto</b>	1352 netto <b>1662,96 brutto</b>	1412 netto <b>1736,76 brutto</b>	P
		szare nogi [FR GR]		1278 netto <b>1571,94 brutto</b>	1299 netto <b>1597,77 brutto</b>	1335 netto <b>1642,05 brutto</b>	1368 netto <b>1682,64 brutto</b>	1428 netto <b>1756,44 brutto</b>	P
		chromowane nogi [FR CR]		1365 netto <b>1678,95 brutto</b>	1386 netto <b>1704,78 brutto</b>	1422 netto <b>1749,06 brutto</b>	1455 netto <b>1789,65 brutto</b>	1515 netto <b>1863,45 brutto</b>	P
21	siatka [32] CZARNE PP	czarne nogi [FR BL]		1299 netto <b>1597,77 brutto</b>	1311 netto <b>1612,53 brutto</b>	1329 netto <b>1634,67 brutto</b>	1349 netto <b>1659,27 brutto</b>	1379 netto <b>1696,17 brutto</b>	P
		szare nogi [FR GR]		1316 netto <b>1618,68 brutto</b>	1328 netto <b>1633,44 brutto</b>	1346 netto <b>1655,58 brutto</b>	1366 netto <b>1680,18 brutto</b>	1396 netto <b>1717,08 brutto</b>	P
		chromowane nogi [FR CR]		1403 netto <b>1725,69 brutto</b>	1415 netto <b>1740,45 brutto</b>	1433 netto <b>1762,59 brutto</b>	1453 netto <b>1787,19 brutto</b>	1483 netto <b>1824,09 brutto</b>	P
21	siatka [32] SZARE PP	czarne nogi [FR BL]		1349 netto <b>1659,27 brutto</b>	1361 netto <b>1674,03 brutto</b>	1379 netto <b>1696,17 brutto</b>	1399 netto <b>1720,77 brutto</b>	1429 netto <b>1757,67 brutto</b>	P
		szare nogi [FR GR]		1365 netto <b>1678,95 brutto</b>	1377 netto <b>1693,71 brutto</b>	1407 netto <b>1730,61 brutto</b>	1457 netto <b>1792,11 brutto</b>	1537 netto <b>1890,51 brutto</b>	P
		chromowane nogi [FR CR]		1453 netto <b>1787,19 brutto</b>	1465 netto <b>1801,95 brutto</b>	1483 netto <b>1824,09 brutto</b>	1503 netto <b>1848,69 brutto</b>	1533 netto <b>1885,59 brutto</b>	P
21	tworzywo sztuczne [33] CZARNE PP	czarne nogi [FR BL]	1170 netto <b>1439,10 brutto</b>					P	
		szare nogi [FR GR]	1199 netto <b>1474,77 brutto</b>					P	
		chromowane nogi [FR CR]	1270 netto <b>1562,10 brutto</b>					P	
21	tworzywo sztuczne [33] SZARE PP	czarne nogi [FR BL]	1219 netto <b>1499,37 brutto</b>					P	
		szare nogi [FR GR]	1245 netto <b>1531,35 brutto</b>					P	
		chromowane nogi [FR CR]	1325 netto <b>1629,75 brutto</b>					P	
21	W celu otrzymania ceny ławki z jednym stolikiem należy odjąć 100 zł netto od ceny netto dowolnej ławki.								P

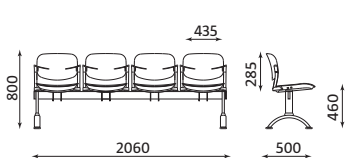
oferta: P – premium, S – standard, EX – express

ważne informacje	objętość kartonu [m <sup>3</sup> ]	ilość w kartonie [szt.]	waga netto 1 szt. [kg]	siedzisko		MODEL wymiary podane w mm	
				szer. [mm]	głęb. [mm]		
	0,22	1	30,00	460	480		STEP – 431 BL – FR BL
							STEP – 431 BL – FR GR
							STEP – 431 BL – FR CR
	0,22	1	30,00	460	480		STEP – 431 GR – FR BL
							STEP – 431 GR – FR GR
							STEP – 431 GR – FR CR
	0,22	1	30,00	460	480		STEP – 432 BL – FR BL
							STEP – 432 BL – FR GR
							STEP – 432 BL – FR CR
	0,22	1	30,00	460	480		STEP – 432 GR – FR BL
							STEP – 432 GR – FR GR
							STEP – 432 GR – FR CR
	0,22	1	30,00	450	460		STEP – 433 BL – FR BL
							STEP – 433 BL – FR GR
							STEP – 433 BL – FR CR
	0,22	1	30,00	450	460		STEP – 433 GR – FR BL
							STEP – 433 GR – FR GR
							STEP – 433 GR – FR CR
							Stolik dla ławek [T]

\*Certyfikat REMODEX dotyczy również wersji ławki ze stolikiem

333, 433 – pierwsza cyfra oznacza liczbę miejsc, dwie następne typ siedziska i oparcie  
 431 – cztery miejsca, tapicerowane siedzisko i oparcie  
 432 – cztery miejsca, tapicerowane siedzisko i oparcie z siatki  
 433 – cztery miejsca, siedzisko i oparcie z tworzywa sztucznego  
 BL (po cyfrze) – elementy z tworzywa sztucznego w kolorze czarnym  
 GR (po cyfrze) – elementy z tworzywa sztucznego w kolorze szarym RAL 7045  
 Np. 432GR – cztery miejsca, tapicerowane siedzisko, oparcie z siatki, elementy z tworzywa sztucznego w kolorze szarym RAL 7045 (osłona siedziska i oparcia, rama)













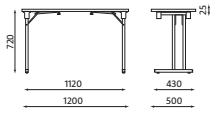

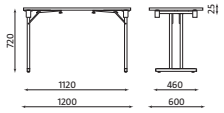
FR – rama  
 BL (po symbolu FR) – nogi ławki w kolorze czarnym  
 GR (po symbolu FR) – nogi ławki w kolorze szarym RAL 7045  
 CR (po symbolu FR) – chromowane nogi ławki  
 T – stolik zamiast siedziska  
 Np. STEP – 433 GR – FR CR – T

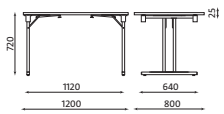

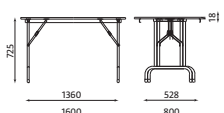

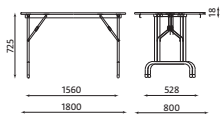
TERMIN REALIZACJI	SIEDZISKO I OPARCIE	RAMA	SIEDZISKO	CENA MODELU W ZALEŻNOŚCI OD WYKOŃCZENIA [zł]					OFERTA
				TAP. PODST. (C) MICRO (M) SKAJ (V)	OBAN (EF) LUCIA (YB)	SOTI (SI)	CONTRACT (YN) NEXUS (UNY)	OXYGEN (OX)	
21	tapicerowane [31] CZARNE PP	czarne nogi [FR BL]	4	1536 netto <b>1889,28 brutto</b>	1564 netto <b>1923,72 brutto</b>	1612 netto <b>1982,76 brutto</b>	1656 netto <b>2036,88 brutto</b>	1736 netto <b>2135,28 brutto</b>	P
		szare nogi [FR GR]		1552 netto <b>1908,96 brutto</b>	1580 netto <b>1943,40 brutto</b>	1628 netto <b>2002,44 brutto</b>	1672 netto <b>2056,56 brutto</b>	1752 netto <b>2154,96 brutto</b>	P
		chromowane nogi [FR CR]		1639 netto <b>2015,97 brutto</b>	1667 netto <b>2050,41 brutto</b>	1715 netto <b>2109,45 brutto</b>	1759 netto <b>2163,57 brutto</b>	1839 netto <b>2261,97 brutto</b>	P
21	tapicerowane [31] SZARE PP	czarne nogi [FR BL]		1585 netto <b>1949,55 brutto</b>	1613 netto <b>1983,99 brutto</b>	1661 netto <b>2043,03 brutto</b>	1705 netto <b>2097,15 brutto</b>	1785 netto <b>2195,55 brutto</b>	P
		szare nogi [FR GR]		1602 netto <b>1970,46 brutto</b>	1630 netto <b>2004,90 brutto</b>	1678 netto <b>2063,94 brutto</b>	1772 netto <b>2179,56 brutto</b>	1802 netto <b>2216,46 brutto</b>	P
		chromowane nogi [FR CR]		1689 netto <b>2077,47 brutto</b>	1717 netto <b>2111,91 brutto</b>	1765 netto <b>2170,95 brutto</b>	1809 netto <b>2225,07 brutto</b>	1889 netto <b>2323,47 brutto</b>	P
21	siatka [32] CZARNE PP	czarne nogi [FR BL]		1631 netto <b>2006,13 brutto</b>	1659 netto <b>2040,57 brutto</b>	1707 netto <b>2099,61 brutto</b>	1751 netto <b>2153,73 brutto</b>	1831 netto <b>2252,13 brutto</b>	P
		szare nogi [FR GR]		1648 netto <b>2027,04 brutto</b>	1676 netto <b>2061,48 brutto</b>	1724 netto <b>2120,52 brutto</b>	1768 netto <b>2174,64 brutto</b>	1848 netto <b>2273,04 brutto</b>	P
		chromowane nogi [FR CR]		1731 netto <b>2129,13 brutto</b>	1759 netto <b>2163,57 brutto</b>	1835 netto <b>2257,05 brutto</b>	1955 netto <b>2404,65 brutto</b>	2155 netto <b>2650,65 brutto</b>	P
21	siatka [32] SZARE PP	czarne nogi [FR BL]		1656 netto <b>2036,88 brutto</b>	1684 netto <b>2071,32 brutto</b>	1732 netto <b>2130,36 brutto</b>	1776 netto <b>2184,48 brutto</b>	1856 netto <b>2282,88 brutto</b>	P
		szare nogi [FR GR]		1672 netto <b>2056,56 brutto</b>	1700 netto <b>2091,00 brutto</b>	1748 netto <b>2150,04 brutto</b>	1792 netto <b>2204,16 brutto</b>	1872 netto <b>2302,56 brutto</b>	P
		chromowane nogi [FR CR]		1760 netto <b>2164,80 brutto</b>	1788 netto <b>2199,24 brutto</b>	1836 netto <b>2258,28 brutto</b>	1880 netto <b>2312,40 brutto</b>	1960 netto <b>2410,80 brutto</b>	P
21	tworzywo sztuczne [33] CZARNE PP	czarne nogi [FR BL]	1506 netto <b>1852,38 brutto</b>					P	
		szare nogi [FR GR]	1515 netto <b>1863,45 brutto</b>					P	
		chromowane nogi [FR CR]	1585 netto <b>1949,55 brutto</b>					P	
21	tworzywo sztuczne [33] SZARE PP	czarne nogi [FR BL]	1506 netto <b>1852,38 brutto</b>					P	
		szare nogi [FR GR]	1523 netto <b>1873,29 brutto</b>					P	
		chromowane nogi [FR CR]	1610 netto <b>1980,30 brutto</b>					P	
21	W celu otrzymania ceny ławki z jednym stolikiem należy odjąć 100 zł netto od ceny netto dowolnej ławki.								

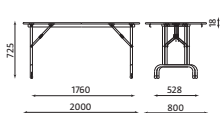





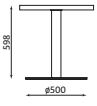

oferta: P – premium, S – standard, EX – express

ważne informacje	objętość kartonu [m <sup>3</sup> ]	ilość w kartonie [szt.]	waga netto 1 szt. [kg]	MODEL wymiary podane w mm		TERMIN REALIZACJI	CENA [zł] (z blatem melaminowym)	OFERTA
	0,60	1	15,20			14	474 netto <b>583,02 brutto</b>	P
	0,60	1	18,00			14	482 netto <b>592,86 brutto</b>	P
	0,60	1	25,60			14	526 netto <b>646,98 brutto</b>	P
	0,90	1	24,50			7	360 netto <b>442,80 brutto</b>	S, EX
						7	347 netto <b>426,81 brutto</b>	S, EX
	0,10	1	27,00			7	386 netto <b>474,78 brutto</b>	S, EX
						7	368 netto <b>452,64 brutto</b>	S, EX
	0,12	1	31,00			7	412 netto <b>506,76 brutto</b>	S, EX
						7	388 netto <b>477,24 brutto</b>	S, EX

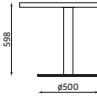

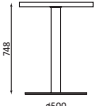

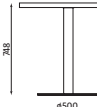

Produkty posiadają Attest Badań Wytrzymałościowych.

Nowy Styl zastrzega sobie prawo do zmian: konstrukcyjnych, wymiarów, terminów dostaw; usunięcia produktów i zmian w palecie wykończeń.



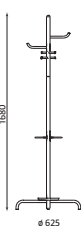

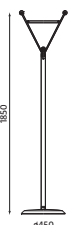



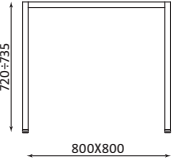

ważne informacje	objętość kartonu [m <sup>3</sup> ]	ilość w kartonie [szt.]	waga netto 1 szt. [kg]	MODEL		TERMIN REALIZACJI	CENA [zł]	OFERTA	
				wymiary podane w mm			TOP 36 MA-NG, MA-NT, MA-BI, MA-CC		
	0,075	1	21,10			LARA INOX 580 blat ø 600	14	531 netto <b>653,13 brutto</b>	P
	0,095	1	25,40			LARA INOX 580 blat ø 800	14	596 netto <b>733,08 brutto</b>	P
	0,106	1	21,40			LARA INOX 730 blat ø 600	14	547 netto <b>672,81 brutto</b>	P
	0,126	1	25,70			LARA INOX 730 blat ø 800	14	612 netto <b>752,76 brutto</b>	P

\* Lara Inox sprzedawana jest jako kompletny stół z blatem melaminowym TOP 36

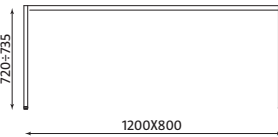
## wieszaki

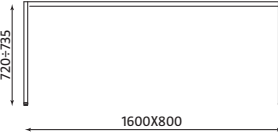
objętość kartonu [m <sup>3</sup> ]	ilość w kartonie [szt.]	waga netto 1 szt. [kg]	MODEL	TERMIN REALIZACJI	CENA [zł]	OFERTA		
			wymiary podane w mm					
0,03	1	4,60			ARIZONA alu/kwarc	7	154 netto <b>189,42 brutto</b>	EX
					ARIZONA black	5	145 netto <b>178,35 brutto</b>	EX
					ARIZONA chrome	7	172 netto <b>211,56 brutto</b>	EX
0,11	1	11,12			TOP	21	289 netto <b>355,47 brutto</b>	P

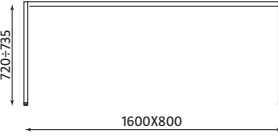





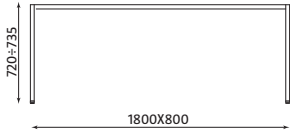

oferta: P – premium, S – standard, EX – express

składowanie w stosie [max. ilość szt.]	objętość kartonu [m <sup>3</sup> ]	ilość w kartonie [szt.]	ilość na EUROPALETCE	waga brutto [kg]	MODEL wymiary podane w mm		TERMIN REALIZACJI	CENA [zł] (z blatem melaminowym)	OFERTA
20	0,04	1	20	19,5			21	417 netto <b>512,91 brutto</b>	P
					SIMPLE 80×80/9006/ MA/18				
20	0,05	1	20	21,6			21	425 netto <b>522,75 brutto</b>	P
					SIMPLE 120×60/9006/ MA/18				
20	0,07	1	20	25,1			21	481 netto <b>591,63 brutto</b>	P
					SIMPLE 120×80/9006/ MA/18				
20	0,09	1	20	31,2			21	591 netto <b>726,93 brutto</b>	P
					SIMPLE 160×80/9006/ MA/18				
20	0,09	1	20	31,2			21	606 netto <b>745,38 brutto</b>	P
					SIMPLE 160×80/C/B/ MA/18				

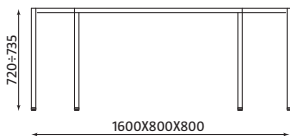

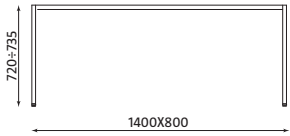
Produkty posiadają Atest Badań Wytrzymałościowych.

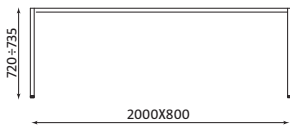
Nowy Styl zastrzega sobie prawo do zmian: konstrukcyjnych, wymiarów, terminów dostaw; usunięcia produktów i zmian w palecie wykończeń.

składowanie w stosie [max. ilość szt.]	objętość kartonu [m <sup>3</sup> ]	ilość w kartonie [szt.]	ilość na EUROPALETCE	waga brutto [kg]	MODEL wymiary podane w mm		TERMIN REALIZACJI	CENA [zł] (z blatem melaminowym)	OFERTA
20	0,1	1		34,0			21	608 netto <b>747,84 brutto</b>	P
								SIMPLE 180×80/9006/ MA/18	
20	0,08	1		18,2			21	571 netto <b>702,33 brutto</b>	P
								SIMPLE 160×80×80/ 9006/MA/18	
20	0,08	1	20	28,2			21	524 netto <b>644,52 brutto</b>	P
								SIMPLE 140×80/9006/ MA/18	
20	0,11	1		37,0			21	621 netto <b>763,83 brutto</b>	P
								SIMPLE 200×80/9006/ MA/18	

oferta: P – premium, S – standard, EX – express

TERMIN REALIZACJI podano w dniach kalendarzowych.



ZP – ZA POTWIERDZENIEM – oznacza każdorazowe uzgadnianie terminu realizacji z Działem Handlowym.





ważne informacje	objętość kartonu [m <sup>3</sup> ]	ilość w kartonie [szt.]	waga netto [kg]	waga brutto [kg]	MODEL wymiary podane w cm		termin realizacji	CENA [zł]		
								MA-CV, MA-NN MA-NG	MA-NE	
	0,065	1	30,80	32,00		BR-01	BIURKO PROSTOKĄTNE 120×68 NOGI PŁYTOWE	5	264 netto <b>324,72 brutto</b>	290 netto <b>356,70 brutto</b>
	0,065	1	33,00	34,40		BR-02	BIURKO PROSTOKĄTNE 137×68 NOGI PŁYTOWE	5	279 netto <b>343,17 brutto</b>	308 netto <b>378,84 brutto</b>
	0,077	1	36,50	38,80		BR-03	BIURKO PROSTOKĄTNE 160×68 NOGI PŁYTOWE	5	309 netto <b>380,07 brutto</b>	339 netto <b>416,97 brutto</b>
	0,145	1	32,50	34,80		BR-04	BIURKO BLAT PODWÓJNA FALA 160×68 NOGI PŁYTOWE	14	374 netto <b>460,02 brutto</b>	412 netto <b>506,76 brutto</b>
	0,097	1	36,20	38,40		BR-05L	BIURKO L LEWE 137×100/68×55 NOGI PŁYTOWE	14	387 netto <b>476,01 brutto</b>	426 netto <b>523,98 brutto</b>
	0,097	1	36,20	38,40		BR-05R	BIURKO L PRAWE 137×100/68×55 NOGI PŁYTOWE	14	387 netto <b>476,01 brutto</b>	426 netto <b>523,98 brutto</b>
	0,111	1	42,60	45,00		BR-06L	BIURKO L LEWE 160×100/68×55 NOGI PŁYTOWE	14	421 netto <b>517,83 brutto</b>	463 netto <b>569,49 brutto</b>

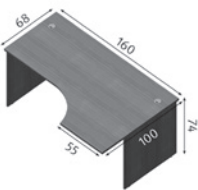
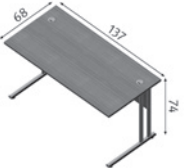

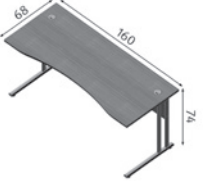
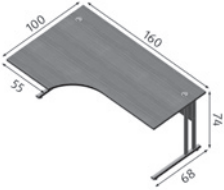
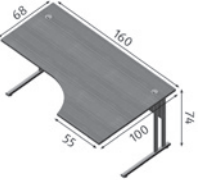
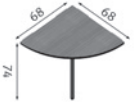
Produkty posiadają Atest Badań Wytrzymałościowych.

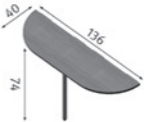
Nowy Styl zastrzega sobie prawo do zmian: konstrukcyjnych, wymiarów, terminów dostaw; usunięcia produktów i zmian w palecie wykończeń.

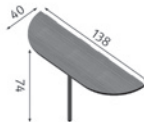
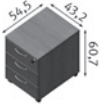
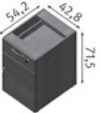
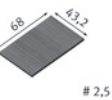
ważne informacje	objętość kartonu [m <sup>3</sup> ]	ilość w kartonie [szt.]	waga netto [kg]	waga brutto [kg]	MODEL wymiary podane w cm		termin realizacji	CENA [zł]		
								MA-CV, MA-NN MA-NG	MA-NE	
	0,111	1	42,60	45,00		BR-06R	BIURKO L PRAWE 160×100/68×55 NOGI PŁYTOWE	14	421 netto <b>517,83</b> brutto	463 netto <b>569,49</b> brutto
	0,115	1	30,00	31,30		BC-02	BIURKO PROSTOKĄTNE 137×68 NA NODZE C	5	403 netto <b>495,69</b> brutto	443 netto <b>544,89</b> brutto
	0,120	1	33,00	35,30		BC-03	BIURKO PROSTOKĄTNE 160×68 NA NODZE C	5	429 netto <b>527,67</b> brutto	472 netto <b>580,56</b> brutto
	0,120	1	32,50	34,80		BC-04	BIURKO BLAT PODWÓJNA FALA 160×68 NA NODZE C	14	492 netto <b>605,16</b> brutto	541 netto <b>665,43</b> brutto
	0,158	1	39,20	41,60		BC-06L	BIURKO L LEWE 160×100/68×55 NA NODZE C	14	525 netto <b>645,75</b> brutto	578 netto <b>710,94</b> brutto
	0,158	1	39,20	41,60		BC-06R	BIURKO L PRAWE 160×100/68×55 NA NODZE C	14	525 netto <b>645,75</b> brutto	578 netto <b>710,94</b> brutto
	0,045	1	7,80	8,7		DB-01	ŁĄCZNIK 68×68	14	193 netto <b>237,39</b> brutto	212 netto <b>260,76</b> brutto

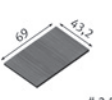



ważne informacje	objętość kartonu [m <sup>3</sup> ]	ilość w kartonie [szt.]	waga netto [kg]	waga brutto [kg]	MODEL wymiary podane w cm		termin realizacji	CENA [zł]		
								MA-CV, MA-NN MA-NG	MA-NE	
	0,045	1	10,70	11,85		DB-02	DOSTAWKA 136×40	14	231 netto <b>284,13 brutto</b>	254 netto <b>312,42 brutto</b>
	0,028	1	11,30	11,92		DB-03	DOSTAWKA 138×40	14	231 netto <b>284,13 brutto</b>	254 netto <b>312,42 brutto</b>
	0,154	1	24,20	27,00		KM-01	KONTENER MOBILNY	5	418 netto <b>514,14 brutto</b>	460 netto <b>565,80 brutto</b>
	0,200	1	23,60	26,00		KS-01	KONTENER STACJONARNY	5	330 netto <b>405,90 brutto</b>	362 netto <b>445,26 brutto</b>
	0,012	1	5,00	5,80		PK-01	POKRYWKA DO KONTENERA STACJONARNEGO 68×43	5	65 netto <b>79,95 brutto</b>	71 netto <b>87,33 brutto</b>
	0,01	1	4,00	4,70		PK-02	POKRYWKA DO KONTENERA STACJONARNEGO 55×43	14	65 netto <b>79,95 brutto</b>	71 netto <b>87,33 brutto</b>
	0,011	1	5,20	5,55		PK-03	POKRYWKA DO KONTENERA STACJONARNEGO 69×43	14	65 netto <b>79,95 brutto</b>	71 netto <b>87,33 brutto</b>



Produkty posiadają Atest Badań Wytrzymałościowych.

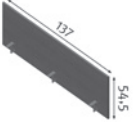
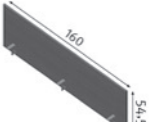

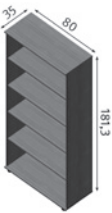
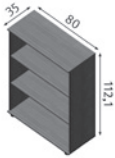





Nowy Styl zastrzega sobie prawo do zmian: konstrukcyjnych, wymiarów, terminów dostaw; usunięcia produktów i zmian w palecie wykończeń.

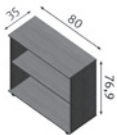

ważne informacje	objętość kartonu [m <sup>3</sup> ]	ilość w kartonie [szt.]	waga netto [kg]	waga brutto [kg]	MODEL wymiary podane w cm		termin realizacji	CENA [zł]		
								MA-CV, MA-NN MA-NG	MA-NE	
	0,019	1	7,00	7,80	 137 54,5	PG-02	PANEL GÓRNY FRONTOWY 137	14	155 netto <b>190,65 brutto</b>	171 netto <b>210,33 brutto</b>
	0,022	1	7,80	8,50	 160 54,5	PG-03	PANEL GÓRNY FRONTOWY 160	14	168 netto <b>206,64 brutto</b>	185 netto <b>227,55 brutto</b>
	0,005	1	0,42	0,64	 48 30	PB-01	TABLICA TAPICEROWANA 48×30	14	58 netto <b>71,34 brutto</b>	
	0,011	1	0,86	1,05	 78 30	PB-02	TABLICA TAPICEROWANA 78×30	14	79 netto <b>97,17 brutto</b>	
	0,077	1	37,00	38,30	 35 80 181,3	RG-01	REGAŁ 80×5 OH	5	352 netto <b>432,96 brutto</b>	388 netto <b>477,24 brutto</b>
	0,48	1	23,70	24,80	 35 80 112,1	RG-02	REGAŁ 80×3 OH	5	248 netto <b>305,04 brutto</b>	273 netto <b>335,79 brutto</b>
	0,056	1	31,10	32,50	 35 60 181,3	RG-03	REGAŁ 60×5 OH	14	313 netto <b>384,99 brutto</b>	344 netto <b>423,12 brutto</b>

TERMIN REALIZACJI podano w dniach kalendarzowych.



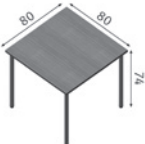

ZP – ZA POTWIERDZENIEM – oznacza każdorazowe uzgadnianie terminu realizacji z Działem Handlowym.

ważne informacje	objętość kartonu [m <sup>3</sup> ]	ilość w kartonie [szt.]	waga netto [kg]	waga brutto [kg]	MODEL wymiary podane w cm		termin realizacji	CENA [zł]	
								MA-CV, MA-NN MA-NG	MA-NE
	0,042	1	15,20	16,00	 RG-04	REGAŁ 80×2 OH	14	204 netto <b>250,92 brutto</b>	224 netto <b>275,52 brutto</b>
	0,085	1	37,70	39,50	 SU-01R	SZAFKA UBRANIOWA PRAWA	14	434 netto <b>533,82 brutto</b>	477 netto <b>586,71 brutto</b>
	0,038	1	17,40	19,00	 DR-01	DRZWI DO SZAFY 80×5 OH	5	209 netto <b>257,07 brutto</b>	230 netto <b>282,90 brutto</b>
	0,027	1	10,50	11,20	 DR-02	DRZWI DO SZAFY 80×3 OH	5	147 netto <b>180,81 brutto</b>	162 netto <b>199,26 brutto</b>
	0,018	1	6,90	7,40	 DR-04	DRZWI DO SZAFY 80×2 OH	5	122 netto <b>150,06 brutto</b>	134 netto <b>164,82 brutto</b>
	0,04	1	13,00	14,50	 DR-03R	DRZWI DO SZAFY 60×5 OH PRAWA	14	137 netto <b>168,51 brutto</b>	150 netto <b>184,50 brutto</b>
	0,046	1	24,00	25,40	 BK-01	STÓŁ KONFERENCYJNY 80×80	14	395 netto <b>485,85 brutto</b>	435 netto <b>535,05 brutto</b>

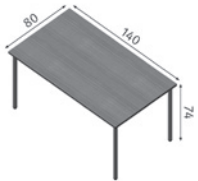

Produkty posiadają Atest Badań Wytrzymałościowych.

Nowy Styl zastrzega sobie prawo do zmian: konstrukcyjnych, wymiarów, terminów dostaw; usunięcia produktów i zmian w palecie wykończeń.

ważne informacje	objętość kartonu [m <sup>3</sup> ]	ilość w kartonie [szt.]	waga netto [kg]	waga brutto [kg]	MODEL wymiary podane w cm		termin realizacji	CENA [zł]		
								MA-CV, MA-NN MA-NG	MA-NE	
	0,08	1	30,00	31,50		BK-02	STÓŁ KONFERENCYJNY 140×80	5	479 netto <b>589,17 brutto</b>	527 netto <b>648,21 brutto</b>
	0,0007	1	0,025	0,05		SK-01	PLASTIKOWE KLIPSY – 4 SZT.	14	26 netto <b>31,98 brutto</b>	
	0,0021	1	0,555	0,56		PZ-01	LISTWA ZASILAJĄCA	14	49 netto <b>60,27 brutto</b>	
	0,009	1	1,54	1,80		NG-01	1 NOGA W KOLORZE KWARC	14	71 netto <b>87,33 brutto</b>	

TKANINA	SYMBOL	GRAMATURA	SKŁAD	ODPORNOŚĆ NA ŚCIERANIE	ATEST NIEPALNOŚCI	INNE WŁAŚCIWOŚCI
<b>24/7</b>	WK	435 g/m <sup>2</sup>	50% poliamid, 30% bawełna, 10% visil 7% wiskoza	500 000 cykli Martindale	EN 1021 1&2 (papieros i zapałka) BS 7176: niskie ryzyko BS 7176: średnie ryzyko BS 5852 section 4 crib 5 UNI 9175 CLASSE 1 IM	
<b>CARTOONS LINE</b>		230 g/m <sup>2</sup>	100% poliester	50 000 cykli Martindale		atest bezpieczeństwa produktów włókienniczych wydany przez Instytut Włókiennictwa: KT/B/08/IW
<b>CONTRACT</b>	YN	320 g/m <sup>2</sup>	100% poliester	100 000 cykli Martindale	EN 1021 1&2 (papieros i zapałka) BS 7176: niskie ryzyko BS 7176: średnie ryzyko NF-P-503 M1 DIN 4102 B1 UNI 8456 & UNI 9174 Class 1	tkanina ekologiczna - 100% z recyklingu europejski certyfikat ekologiczny – EU Ecolabel (tzw. Europejska Stokrotka)
<b>KID</b>	KID	200 g/m <sup>2</sup>	100% poliester	41 000 cykli Martindale		atest bezpieczeństwa produktów włókienniczych wydany przez Instytut Włókiennictwa: KT/B/08/IW
<b>LUCIA</b>	YB	260 g/m <sup>2</sup>	100% poliester	50 000 cykli Martindale	EN 1021 1&2 (papieros i zapałka) BS 7176: niskie ryzyko BS 476: Class 1	atest higieniczny wydany przez Państwowy Zakład Higieny: PN-88/B-02855 europejski certyfikat ekologiczny – EU Ecolabel (tzw. Europejska Stokrotka)
<b>MICRO</b>	M	190 g/m <sup>2</sup>	100% poliester	50 000 cykli Martindale	EN 1021 1&2 (papieros i zapałka)	atest higieniczny wydany przez Państwowy Zakład Higieny: PN-88/B-02855
<b>MICROFIBRA</b>	CM	460 g/m <sup>2</sup>	warstwa wierzchnia: 100% poliester podkład: 70% bawełna, 30% poliester	35 000 cykli Martindale	BS 5852: part 1: 1979 (papieros i zapałka)	certyfikat Öko Tex 100 - certyfikat potwierdzający, że podczas całego procesu produkcyjnego tkaniny nie zostały użyte substancje szkodliwe dla zdrowia
<b>NEXUS</b>	UNY	300 g/m <sup>2</sup>	100% poliester	100 000 cykli Martindale	EN 1021 1&2 (papieros i zapałka) BS 7176: niskie ryzyko	
<b>NOBLE LUX</b>	NL	285 g/m <sup>2</sup>	warstwa wierzchnia: 100% poliester podkład: 90% poliester, 10% bawełna	45 000 cykli Martindale	BS 5852 (papieros)	certyfikat Öko Tex 100 - certyfikat potwierdzający, że podczas całego procesu produkcyjnego tkaniny nie zostały użyte substancje szkodliwe dla zdrowia



TKANINA	SYMBOL	GRAMATURA	SKŁAD	ODPORNOŚĆ NA ŚCIERANIE	ATEST NIEPALNOŚCI	INNE WŁAŚCIWOŚCI
<b>OBAN</b>	EF	230 g/m <sup>2</sup>	100% polyolefin	BS EN 14465:2003 Stopień A	EN 1021-1 (papieros)	atest higieniczny wydany przez Państwowy Zakład Higieny: PN-88/B-02855
<b>OXYGEN</b>	OX	400 g/m <sup>2</sup>	90% wełna, 10% poliamid	100 000 cykli Martindale	EN 1021 1&2 (papieros i zapałka) BS 7176: niskie ryzyko UNI 9175 Classe 1 IM	tkanina ekologiczna; wszystkie procesy związane z produkcją i transportem tkaniny są neutralne dla środowiska
<b>SIATKA (@-MOTION)</b>		353 g/m <sup>2</sup>	100% poliester			certyfiakat Öko Tex 100 - certyfiakat potwierdzający, że podczas całego procesu produkcyjnego tkaniny nie zostały użyte substancje szkodliwe dla zdrowia
<b>SIATKA NT</b>	NT	262 g/m <sup>2</sup>	100% poliester		EN 1021 1&2 (papieros i zapałka)	PN-E-05 203 : 1992 właściwości antystatyczne potwierdzone certyfikatem wydanym przez Polski Instytut Włókiennictwa
<b>SIATKA OP</b>	OP	248 g/m <sup>2</sup>	100% poliester		EN 1021 1&2 (papieros i zapałka) dotyczy tylko OP-24N	
<b>SKAJ</b>	V	450 g/m <sup>2</sup>	100% poliester pokryty warstwą PCW	50 000 cykli Martindale	niektóre kolory (oznaczone literą N) posiadają atest na niepalność BS 5852: part 1: 1979 (papieros i zapałka)	łatwozmywalny
<b>SKÓRA DWOINA</b>	SP		skóra dwoina, lakierowana			
<b>SKÓRA LICOWA</b>	SD		miękką skórą licową, lakierowaną			
<b>SOTI EKO-SKÓRA</b>	SI	390 g/m <sup>2</sup>	warstwa wierzchnia: 53% poliuretan podkład: 15% bawełna, 32% poliester	40 000 cykli Martindale	BS 5852 (papieros i zapałka) EN 1021 1&2 (papieros i zapałka)	atest higieniczny wydany przez Państwowy Zakład Higieny: PN-88/B-02855
<b>TKANINA PODSTAWOWA</b>	C/CU	260 g/m <sup>2</sup>	100% włókno syntetyczne	30 000 cykli Martindale		

## ZNACZENIE SYMBOLI

ALU	Wersja z metalowymi elementami pokrytymi lakierem w kolorze aluminium	HR	Wersja z zagłówkiem
ARM	Wersja z podłokietnikami	HRU	Wersja z zagłówkiem tapicerowanym
B PLUS	Wersja, w której przednia część krzesła jest tapicerowana w całości	KWARC	Wersja z metalowymi elementami pokrytymi lakierem w kolorze kwarc
BIANCO	Wersja z plastikowymi elementami w kolorze jasnopopielatym	LB	Wersja z niskim oparciem
BLACK	Wersja z metalowymi elementami pokrytymi lakierem w kolorze czarnym	LINK	Dodatkowy element pozwalający na łączenie krzeseł w rzędy
CF	Wersja na płozie	LU	Wersja z podparciem lędźwi
CFA	Wersja na płozie z tyłu i nogach z przodu	PLUS	Wersja z tapicerowanym siedziskiem i oparciem
CFN	Wersja na drewnianej płozie i drewnianych podłokietnikach	PROFIL	Wersja z ergonomicznie wyprofilowanym oparciem
CFP	Wersja na płozie z podłokietnikami	R	Wersja z podłokietnikami o regulowanej wysokości
CFS	Wersja na płozie bez podłokietników	SEAT PLUS	Wersja z tapicerowanym siedziskiem
CHROME	Wersja z chromowanymi elementami metalowymi	STEEL	Wersja z wykończeniem metalowym lub aluminiowym
CLICK	Wersja ramy wyposażona w element łączący krzesła w rzędy	T	Wersja z pulpitem dla praworęcznych
ERGO	Wersja z ergonomicznie wyprofilowanym siedziskiem i/lub oparciem	T/L	Wersja z pulpitem dla leworęcznych
GTP	Wersja obrotowa na podnośniku pneumatycznym z podłokietnikami	TE	Wersja z pulpitem wykonanym ze sklejki dla praworęcznych
GTS	Wersja obrotowa na podnośniku pneumatycznym bez podłokietników	TE/L	Wersja z pulpitem wykonanym ze sklejki dla leworęcznych
HB	Wersja z wysokim oparciem		

## DYWAN CZY PARKIET?



W ofercie PREMIUM i STANDARD istnieje możliwość wyboru kółek już przy zakupie fotela gabinetowego lub krzesła obrotowego.

Dopłata przy zamówieniu modelu z kółkami samohamownymi do parkietów i powierzchni twardych:

11 zł netto

**13,53 zł brutto**

W ofercie EXPRESS istnieje możliwość dokupienia kompletu kółek samohamownych do parkietów i powierzchni twardych:

25 zł netto

**30,75 zł brutto**



Kółka samohamowne do parkietów i powierzchni twardych. Plastikowe kółka pokryte są cienką, gumową oponką zabezpieczającą przed zniszczeniem powierzchni parkietów, paneli oraz podłóg kamiennych, po których porusza się krzesło.

## RODZAJE KÓŁEK



Kółka samohamowne do powierzchni dywanowych. Twarde, plastikowe kółka poruszają się lekko po miękkich powierzchniach, takich jak dywany i wykładziny dywanowe.



Produkty posiadają Atest Badań Wytrzymałościowych.

Nowy Styl zastrzega sobie prawo do zmian: konstrukcyjnych, wymiarów, terminów dostaw; usunięcia produktów i zmian w palecie wykończeń.

# ORGANIZACJA ZESPOŁU HANDLOWCÓW

## Mapa podziału na regiony



REGION	MENEDŻER HANDLOWY	HANDLOWIEC W KROŚNIE
<b>1</b>	tel. 510 005 <b>461</b>	tel. (013) 43 76 <b>119</b>
<b>2</b>	tel. 510 005 <b>469</b>	tel. (013) 43 76 <b>229</b>
<b>3</b>	tel. 510 005 <b>463</b>	tel. (013) 43 76 <b>146</b>
<b>4</b>	tel. 510 005 <b>464</b>	tel. (013) 43 76 <b>246</b>
<b>5</b>	tel. 510 005 <b>466</b>	tel. (013) 43 76 <b>149</b>
<b>6</b>	tel. 510 005 <b>465</b>	tel. (013) 43 76 <b>132</b>
<b>7</b>	tel. 510 005 <b>467</b>	tel. (013) 43 76 <b>232</b>
<b>8</b>	tel. 510 005 <b>476</b>	tel. (013) 43 76 <b>218</b>

fax (013) 43 62 **603**

EDYCJA 3

Data wydania:  
marzec 2012

Nowy Styl  
Dział Sprzedaży Krajowej  
ul. Pużaka 12  
38-400 Krosno  
kraj@nowystylgroup.com

Centrum informacji:  
tel. 0 801 177 291

→ [www.nowystyl.pl](http://www.nowystyl.pl)



Wykorzystaj swój smartphone i dowiedz się więcej na temat oferty marki Nowy Styl. Jeśli nie masz oprogramowania niezbędnego do odczytania fotokodów, możesz je pobrać za darmo, np. ze strony [www.lynkee.com](http://www.lynkee.com)

**NOWY STYL GROUP**

Marka Nowy Styl  
należy do oferty Nowy Styl Group

[www.nowystylgroup.com](http://www.nowystylgroup.com)

> **więcej możliwości**